

The new Standard by i-PRO video surveillance

Full HD Vandal Resistant Indoor Dome Network Camera with AI engine

The S-Series network cameras offer a new standard in i-PRO video surveillance with drastically improved image quality with advanced technology. It comes with pre-installed AI analytics applications that detects people and vehicles with accuracy, allowing you to easily start state-of-the-art video surveillance.

The camera can be configured while keeping the unit in the box with the acclaimed "Easy Kitting Packaging", making the installation process smooth and easy.

Key Features

- Drastically improved image quality by advanced technology and AI intelligent Auto
- Pre-installed AI analytics applications to detect human and vehicles. Ready for installing 3rd party applications
- Detecting suspicious sound like Gunshot, Yell, Vehicle horn, and Glass break, with external microphones
- Easy Kitting Package enabling installers to configure cameras easily while keeping the unit in the box
- i-PRO Configuration Tool "iCT" can set up 1024 cameras at the same time.

(iCT page : https://security.panasonic.com/training_support/design_tools/iCT/)

Key i-PRO Spec.

- Full HD 1080p up to 60fps
- Intelligent Auto (with AI Engine)
- Super Dynamic 144dB
- Color night vision (0.007 to 0.009 lx)
- Smart Coding (with AI Engine)
- Built-in IR LED
- Vandal Resistant
- Onvif Profile G / S / T

Industry examples

- Airport (Passport control / Security checkpoint / Ticket counter)
- Retail / Bank / Education / Hospital / Building



i-PRO

Specifications

Camera	Image Sensor	Approx. 1/2.8 type CMOS image sensor
	Minimum Illumination	Color : 0.007 lx (30IRE, F1.3, 1/30s) ^{*1} Color : 0.009 lx (50IRE, F1.3, 1/30s) BW : 0.006 lx (50IRE, F1.3, 1/30s) BW : 0 lx (50IRE, F1.3, 1/30s with IR LED)
	White Balance	ATW1 / ATW2 / AWC
	Shutter Speed	[60 fps Mode] 1/60 Fix to 1/10000 Fix, [30fps/15fps mode] 1/30 Fix to 1/10000 Fix [50 fps Mode] 1/50 Fix to 1/10000 Fix, [25fps/12.5fps mode] 1/25 Fix to 1/10000 Fix
	Intelligent Auto	On / Off
	Super Dynamic ²	On / Off, The level can be set in the range of 0 to 31.
	Dynamic Range	Max.144 dB (Super Dynamic : On, Level 31)
	Adaptive Black Stretch	The level can be set in the range of 0 to 255.
	Back light compensation / High light compensation	BLC (Back light compensation) / HLC (High light compensation) / Off (only when Super dynamic / Intelligent Auto : Off)
	Fog compensation	On / Off (only when Intelligent auto / auto contrast adjust : Off)
	Maximum gain (AGC)	The level can be set in the range of 0 to 11.
	Color/BW (ICR)	Off / On (IR Light Off) / On (IR Light On) / Auto1 (IR Light Off) / Auto2 (IR Light On) / Auto3 (SCC)
	IR LED Light	High / Middle / Low / Off, Maximum irradiation distance : 70 m (Approx. 230 ft) (50IRE) ^{*1} 50 m (Approx. 164 ft) (30IRE)
	Digital Noise Reduction	The level can be set in the range of 0 to 255.
	Video Motion Detection (VMD)	On / Off, 4 areas available
	Scene Change Detection (SCD)	On / Off, 1 areas available
	Audio Detection	On / Off
	AI Sound classification	Gunshot, Yell, Vehicle horn, Glass break
	AI Analytics	Yes
	Privacy Zone	On / Off, Up to 8 zones available
VIQS	On / Off, Up to 8 zones available	
Image rotation ³	0° / 90° / 180° / 270°	
Camera Title (OSD)	On / Off, Up to 40 characters (alphanumeric characters, marks)	
Focus Adjustment	Auto focus / Manual	
Lens	Optical zoom	3.1 x (Motorized zoom / Motorized Focus)
	Extra zoom	3.1x - 9.3x (when resolution is 640 x 360)
	Focal length	2.9 - 9 mm (1/8 inches - 11/32 inches)
	Angular Field of View	[16:9 mode] Horizontal : 36° (TELE) - 114° (WIDE), Vertical : 20° (TELE) - 60° (WIDE) [4:3 mode] Horizontal : 27° (TELE) - 82° (WIDE), Vertical : 20° (TELE) - 60° (WIDE)
DORI	Maximum Aperture Ratio	1 : 1.3 (WIDE) - 1 : 2.5 (TELE)
	Focusing Range	0.3 m (11-13/16 inches) - ∞
	Detect (25ppm / 8ppf)	Wide: 24.9 m / 81.8 ft, Tele: 118.2 m / 387.7 ft
	Observe (62.5ppm / 19ppf)	Wide: 10.0 m / 32.7 ft, Tele: 47.3 m / 155.1 ft
Adjusting Angle	Recognize (125ppm / 38ppf)	Wide: 5.0 m / 16.4 ft, Tele: 23.6 m / 77.5 ft
	Identify (250ppm / 76ppf)	Wide: 2.5 m / 8.2 ft, Tele: 11.8 m / 38.8 ft
Browser	Camera Control	Brightness, AUX On / Off
	Audio	Mic (Line) Input : On / Off Volume adjustment : Low / Middle / High Audio Output : On / Off Volume adjustment : Low / Middle / High
Network	GUI / Setup Menu Language	English, Italian, French, German, Spanish, Portuguese, Russian, Chinese, Japanese
	Browser ⁴	Microsoft Edge, Firefox, Google Chrome
Network	Network IF	10Base-T / 100Base-TX, RJ45 connector
	Resolution	[16:9 mode (60 fps mode)] ² , [16:9 mode (30 fps mode)], [16:9 mode (50 fps mode)] ² , [16:9 mode (25 fps mode)] 1920x1080, 1280x720, 640x360, 320x180
	H.265/ H.264 / JPEG (MJPEG)	[4:3 mode (30 fps mode)], [4:3 mode (25 fps mode)] 1280x960, VGA, QVGA
	H.265/ H.264 ⁶	[4:3 mode (15 fps mode)], [4:3 mode (12.5 fps mode)] 2048x1536 ⁵ , 1280x960, VGA, QVGA
	Transmission Mode	Constant bit rate / VBR / Frame rate / Best effort
	Transmission Type	Unicast port (AUTO) / Unicast port (MANUAL) / Multicast
	Image Quality	10 steps
Smart Coding	GOP (Group of pictures control):	Off/ Low (Variable GOP 1s-8s)/ Mid (Variable GOP 4s-16s)/ Advanced(Fixed GOP 60s w/1s key-frame)
	Frame rate control (Variable GOP 4s-16s with frame rate control)	*Advanced and Frame rate control are only available with H.265. Smart VIQS: On(High)/On(Low)/Off, Smart P-picture control: On/Off

Network	Audio Compression	G.726 (ADPCM) : 16 kbps / 32 kbps G.711 : 64 kbps AAC-LC ⁷ : 64 kbps / 96 kbps / 128 kbps
	Audio transmission mode	Off / Mic (Line) input / Audio output / Interactive (Half duplex) / Interactive (Full duplex)
Supported Protocol	IPV6: TCP/IP, UDP/IP, HTTP, HTTPS, SSL/TLS, SMTP, DNS, NTP, SNMPv1/v2/v3, DHCPv6, RTP, MLD, ICMP, ARP, IEEE 802.1X, DiffServ	
	IPV4: TCP/IP, UDP/IP, HTTP, HTTPS, SSL/TLS, RTSP, RTP, RTP/RTCP, SMTP, DHCP, DNS, DDNS, NTP, SNMPv1/v2/v3, UPnP, IGMP, ICMP, ARP, IEEE 802.1X, DiffServ, SRTP	
No. of Simultaneous Users	SDXC/SDHC/SD	Up to 14 users (Depends on network conditions)
	Memory Card (Option)	H.265 / H.264 recording : Manual REC / Alarm REC (Pre/Post) / Schedule REC / Backup upon network failure JPEG recording : Manual REC / Alarm REC (Pre/Post) / Backup upon network failure Available SDXC/SDHC/SD Memory Card : microSDXC memory card: 64 GB, 128 GB, 256 GB, 512 GB microSDHC memory card: 4 GB, 8 GB, 16 GB, 32 GB microSD memory card: 2 GB
Mobile Terminal Compatibility	iPad, iPhone, Android™ terminals	
	ONVIF Profile	G / S / T
Alarm	Alarm Source	3 terminals input, VMD alarm, Command alarm, Audio detection alarm
	Alarm Actions	SDXC/SDHC/SD memory recording, E-mail notification, HTTP alarm notification Indication on browser, Panasonic alarm protocol output
Input/Output	Monitor Output (for adjustment)	VBS : 1.0 V [p-p] / 75 Ω, composite, Pin jack An NTSC or PAL signal can be outputted from camera
	Audio input	ø3.5 mm stereo mini jack For microphone input : Recommended applicable microphone : Plug-in power type (Sensitivity of microphone : -48 dB±3 dB (0 dB=1 V/Pa, 1 kHz)) Input impedance : Approx. 2 k Ω (unbalanced) Supply voltage : 2.5 V ±0.5 V For line input : Input level : Approx. -10 dBV
	Audio Output	ø3.5 mm stereo mini jack (monaural output) Output impedance : Approx. 600 Ω (unbalanced) Output level : -20 dBV
	External I/O Terminals	ALARM IN 1 (Alarm input 1/ Black & white input/ Auto time adjustment input) (x1) ALARM IN 2 (Alarm input 2/ ALARM OUT) (x1) ALARM IN 3 (Alarm input 3/ AUX OUT) (x1)
General	Safety	UL (UL62368-1), c-UL (CSA C22.2 No.62368-1), CE, IEC62368-1
	EMC	FCC (Part15 ClassA), ICES-003 ClassA, EN55032 ClassB, EN55035
	Power Source and Power Consumption	DC power supply : DC12 V 720 mA, Approx. 8.6 W PoE (IEEE802.3at compliant) Device : DC48 V 180 mA, Approx. 8.7 W (Class 0 device)
	Ambient Operating Temperature	-10 °C to +50 °C (14 °F to 122 °F)
	Shock Resistance	IK10 (IEC 62262)
	Ambient Operating Humidity	10 to 90 % (no condensation)
	Dimensions	ø129.5 mm x 102.5 mm (H) (ø5-3/32 inches x 4-1/32 inches (H)) Dome radius 41.5 mm (1-5/8 inches)
Mass (approx.)	570 g (1.26 lbs.)	
Finish	Main body : PC resin, i-PRO white / Dome cover : Polycarbonate resin, Clear	

*1 Converted value

*2 When 60 fps or 50 fps is selected, the Super Dynamic function is automatically set to off.

*3 When the 60 fps mode, 50 fps mode, 15 fps mode or 12.5 fps mode is used, the "90°" and "270°" settings are not available. When the 320x180 resolution is used, the "90°" and "270°" settings are not available.

*4 For information on the operation verification of the supported web browsers, refer to our support website <Control No.: C0132>.

*5 Used by super resolution techniques.

*6 Transmission for 4 streams can be individually set.

*7 When recording audio on a microSD memory card, only use AAC-LC (Advanced Audio Coding - Low Complexity).

Appearance

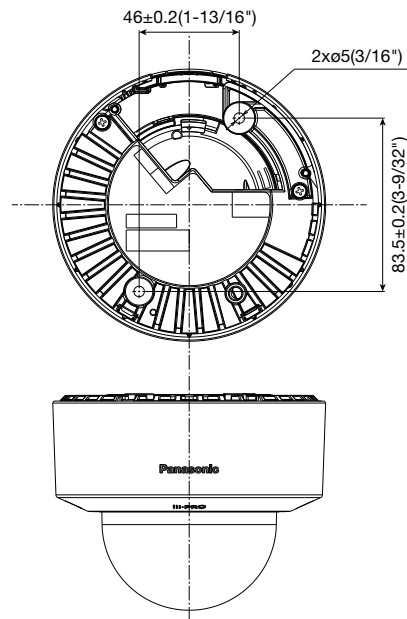
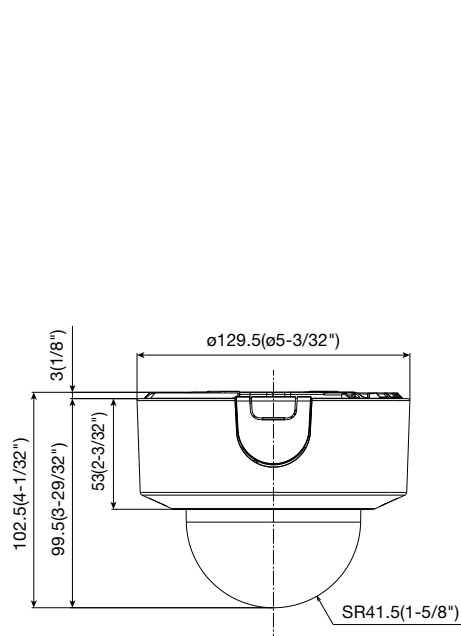

Unit : mm (inches)

AI Analytics applications

AI Video Motion Detection (AI-VMD)

Advanced video analysis technology detects objects (faces, people, cars, motorcycles) in a specified area. (Intruder Detection, Loitering Detection, Direction Detection, Cross Line Detection)

AI Privacy Guard

To protect privacy and portrait rights, it is possible to automatically apply a mosaic the entire face and figure of a person photographed by the camera.

AI Face Detection

Detects faces with high precision even in low-light, backlit, and mask-wearing environments.

AI People Detection











Extract the characteristics of human face / clothing and classify them into meaningful categories such as gender, age, and clothing color.

AI Vehicle Detection

Extract vehicle characteristics and classify them into meaningful categories such as type and color.

Optional Accessories

Mount Bracket / Dome Cover / Other

<p>Ceiling Mount Bracket WV-Q105A</p> 	<p>Ceiling Mount Bracket (Embedded) WV-QEM100-W (i-PRO white)</p> 	<p>Ceiling Mount Bracket WV-QCL101-W (i-PRO white)</p> 	<p>Mount Bracket WV-QSR501-W (i-PRO white)</p>  <p>(This bracket requires WV-QCL501-W or WV-QWL501-W.)</p>	<p>Ceiling Mount Bracket WV-QCL501-W (i-PRO white)</p>  <p>(This bracket requires WV-QSR501-W.)</p>	<p>Wall Mount Bracket WV-QWL501-W (i-PRO white)</p>  <p>(This bracket requires WV-QSR501-W.)</p>
<p>Wall Mount Bracket WV-QWL500-W (i-PRO white)</p> 	<p>Adapter Box WV-QJB500-W (i-PRO white)</p>  <p>(This bracket requires WV-QWL500-W.)</p>	<p>Pole Mount Bracket WV-QPL500-W (i-PRO white)</p>  <p>(This bracket requires WV-QWL501-W or WV-QWL500-W.)</p>	<p>Corner Mount Bracket WV-QCN500-W (i-PRO white)</p>  <p>(This bracket requires WV-QWL501-W or WV-QWL500-W.)</p>	<p>Dome Cover (Smoke Type) WV-CR1S</p> 	

• Brackets are available in four colors, Fine silver, Light gray, Gray and i-PRO white. It is possible to use them in different color combinations.

Trademarks and registered trademarks

- iPad and iPhone are trademarks of Apple Inc., registered in the U.S. and other countries.
- Android is a trademark of Google LLC.
- ONVIF is trademarks or registered trademarks of Onvif Inc.
- All other trademarks identified herein are the property of their respective owners.

Important

- Safety Precautions : Carefully read the Basic Information, Installation Guide and Operating Instructions before using this product.
- Panasonic i-PRO Sensing Solutions Co., Ltd. cannot be held responsible for the performance of the network and/or other manufacturers' products used on the network.

• Masses and dimensions are approximate. • Specifications are subject to change without notice.

Panasonic®

Panasonic Corporation

Panasonic i-PRO Sensing Solutions Co., Ltd.

<https://ipro.panasonic.com>

<https://security.panasonic.com>

<https://www.linkedin.com/company/i-pro-sensing-solutions-co-ltd/>

(2A-276AL)