

8036 SIP Multimedia Intercom FW Version 1.5.1

Installation & Configuration



Order Codes

8036 SIP Multimedia Intercom

Table of Contents

IMPORTANT SAFETY INFORMATION	8
ABOUT THE ALGO 8036 SIP MULTIMEDIA INTERCOM	9
PRODUCT TOUR	10
GETTING STARTED - QUICK INSTALL & TEST	11
INSTALLATION	12
WALL MOUNTING	12
REMOVAL OF FRONT BEZEL FOR INSTALLATION	12
FLUSH MOUNTING INTO DRYWALL (INTERIOR)	13
FLUSH MOUNTING INTO OTHER MATERIALS OR OUTDOORS	14
SURFACE MOUNTING.....	15
MOUNTING HEIGHT	17
POE NETWORK CONNECTION	18
WEB INTERFACE	19
ACCESSING THE CONTROL PANEL	19
FINDING THE IP ADDRESS	19
APPLICATION DEVELOPMENT	21
OVERVIEW	21
CREATING USER INTERFACE SCREENS.....	21
CUSTOM GRAPHIC SCREENS	22
DIRECTORY (ADDRESSBOOK) LISTINGS	22
UPLOADING USER CONTENT.....	22
RESET.....	23
WEB INTERFACE LOGIN	24
STATUS.....	24
STATUS TAB – VIDEO	25
BASIC SETTINGS TAB – SIP.....	26
SIP DOMAIN (PROXY SERVER).....	26
EXTENSION	26
AUTHENTICATION ID	26
AUTHENTICATION PASSWORD.....	27
BASIC SETTINGS TAB – FEATURES	28
SPEAKER VOLUME.....	28
MICROPHONE VOLUME.....	28
UI VOLUME.....	28
ANSWER INBOUND CALL.....	28
OUTBOUND RING LIMIT	29
RINGBACK TONE	29
G.722 SUPPORT.....	29

MAXIMUM CALL DURATION (INBOUND/OUTBOUND CALLS)	29
BASIC SETTINGS TAB - VIDEO	30
VIDEO CALL MODE.....	30
PROFILE LEVEL.....	31
PACKET TYPE	31
QUALITY CONTROL METHOD	31
MAXIMUM BANDWIDTH	31
QP MIN	31
QP MAX.....	31
AUTO WHITE BALANCE	31
EXPOSURE COMPENSATION.....	31
MANUAL EXPOSURE OVERRIDE.....	32
POWERLINE FREQUENCY.....	32
REQUEST MEDIA BANDWIDTH	32
SIP VIDEO STREAM	32
MAXIMUM BROWSER SESSIONS.....	32
SESSION PASSCODE	32
WEB VIDEO RESOLUTION.....	32
BASIC SETTINGS TAB – DOOR CONTROL.....	33
NUMBER OF NETWORK DOOR CONTROLLERS	34
DOOR UNLOCK TONE.....	34
ADDRESS.....	34
PASSWORD.....	34
MOMENTARY OPEN CODE	34
DURATION	34
LATCH OPEN CODE.....	34
LATCH CLOSED CODE	35
ACCESS CODE.....	35
USER INTERFACE TAB – GENERAL.....	36
NUMBER OF ACTIVE PAGES	36
HOME PAGE	37
DEFAULT LCD BRIGHTNESS	37
DOOR UNLOCK MESSAGE	37
USER INTERFACE TIMEOUT	37
TIMEOUT ACTION	37
ACTION ON RESUME	37
LCD BRIGHTNESS AFTER TIMEOUT EVENT.....	38
PRESENCE SENSOR FOR USER INTERFACE	38
ACTION WHEN PRESENCE DETECTED.....	38
INTERVAL BETWEEN SLIDES (SECOND)	38
HANGUP BUTTON	38
ACTION AT END OF CALL.....	38
USER INTERFACE TAB – PAGE (BUTTON TEMPLATE)	39
CUSTOM GRAPHICS AND BACKGROUNDS.....	39
TEMPLATE.....	40

DESCRIPTION	40
BACKGROUND	41
BUTTON LAYOUT	41
ACTION ON BACKGROUND TOUCH EVENT (OUTSIDE OF BUTTONS).....	41
BACK BUTTON.....	41
HOME BUTTON	41
BUTTON #.....	41
TEXT	41
ACTION	42
ACTION – CALL DESTINATION	42
ACTION – TARGET PAGE.....	42
USER INTERFACE TAB – PAGE (DIRECTORY TEMPLATE).....	43
DIRECTORY (ADDRESSBOOK) TEXT FILES.....	43
USER INTERFACE TAB – FILE MANAGER	45
ADVANCED SETTINGS TAB - NETWORK	47
PROTOCOL	47
VLAN MODE.....	47
VLAN ID	48
VLAN PRIORITY	48
DIFFERENTIATED SERVICES (6-BIT DSCP VALUE)	48
ADVANCED SETTINGS TAB – ADMIN	49
PASSWORD.....	49
CONFIRMATION	49
DEVICE NAME (HOSTNAME).....	50
INTRODUCTION SECTION ON STATUS PAGE	50
WEB INTERFACE SESSION TIMEOUT.....	50
PLAY TONE AT STARTUP	50
LOG LEVEL.....	50
LOG METHOD	50
LOG SERVER	50
WEB INTERFACE PROTOCOL	50
FORCE STRONG PASSWORD.....	50
ALLOW SECURE SIP PASSWORD	51
SNMP SUPPORT (V1 GET ONLY)	51
ADVANCED SETTINGS TAB – TIME.....	52
TIMEZONE.....	52
NTP TIME SERVERS 1/2/3/4.....	52
NTP TIME SERVER SOURCE	52
DEVICE DATE/TIME.....	52
ADVANCED SETTINGS TAB – PROVISIONING	54
MD5 CHECKSUM.....	55
GENERATING A GENERIC CONFIGURATION FILE	55
GENERATING A SPECIFIC CONFIGURATION FILE.....	56

ADVANCED SETTINGS TAB – TONES	57
UPLOADING CUSTOM AUDIO FILES	57
ADVANCED SETTINGS TAB – ADVANCED SIP	58
OUTBOUND PROXY	58
STUN SERVER	58
REGISTER PERIOD (SECONDS).....	58
KEEP-ALIVE METHOD.....	59
SERVER REDUNDANCY FEATURE	59
BACKUP SERVER #1.....	59
BACKUP SERVER #2.....	59
POLLING INTERVALS (SECONDS).....	59
POLL ACTIVE SERVER	59
AUTOMATIC FAILBACK	60
POLLING METHOD	60
SYSTEM TAB - MAINTENANCE.....	61
DOWNLOAD CONFIGURATION FILE.....	61
RESTORE CONFIGURATION FILE	61
RESTORE CONFIGURATION TO DEFAULTS	61
DOWNLOAD UI BACKUP SIP FILE	61
RESTORE FROM UI BACKUP ZIP FILE	62
RESTORE ALL UI SETTINGS AND FILE TO DEFAULTS	62
REBOOT THE DEVICE	62
METHOD.....	62
FIRMWARE IMAGE	62
MD5 CHECKSUM.....	62
SYSTEM – SYSTEM LOG	63
SPECIFICATIONS.....	64
8061 IP RELAY CONTROLLER	66
CONFIGURING THE 8061	67
BUTTON POSITIONING TABLE	69
ADOBE® PHOTOSHOP® TEMPLATES	70
FCC COMPLIANCE STATEMENT	71

Important Safety Information

This product is powered by a certified limited power source (LPS), Power over Ethernet (PoE); through CAT5 or CAT6 connection wiring to an IEEE 802.3af compliant network PoE switch. The product is intended for installation indoors or on outdoor perimeter of a building. If used in an outdoor environment, additional protective measures must be taken according to the installation manual. All wiring connections to the product must be in the same building. If the product is installed beyond the building perimeter or used in an inter-building application, the wiring connections must be protected against overvoltage / transient. Algo recommends that this product be installed by a qualified electrician.

If you are unable to understand the English language safety information then please contact Algo by email for assistance before attempting an installation support@algosolutions.com.

Consignes de Sécurité Importantes

Ce produit est alimenté par une source d'alimentation limitée certifiée (alimentation par Ethernet); des câbles de catégorie 5 et 6 joignent un commutateur réseau à alimentation par Ethernet homologué IEEE 802.3af. Le produit est conçu pour être installé à l'intérieur ou dans une zone adjacente à un édifice; selon le manuel d'installation, des mesures de sécurité additionnelles s'avèrent alors nécessaires. Tout le câblage rattaché au produit doit se trouver dans le même édifice. Si le produit est installé au-delà du périmètre de l'édifice ou utilisé pour plusieurs édifices, le câblage doit être protégé des surtensions transitoires. Algo recommande qu'un électricien qualifié se charge de l'installation de ce produit.

Si vous ne pouvez comprendre les consignes de sécurité en anglais, veuillez communiquer avec Algo par courriel avant d'entreprendre l'installation au support@algosolutions.com.

Información de Seguridad Importante

Este producto funciona con una fuente de alimentación limitada (Limited Power Source, LPS) certificada, Alimentación a través de Ethernet (Power over Ethernet, PoE); mediante un cable de conexión CAT5 o CAT6 a un conmutador de red con PoE en cumplimiento con IEEE 802.3af. El producto se debe instalar en lugares cerrados o en el perímetro de un edificio al aire libre. Si se utiliza en un ambiente al aire libre, se deben tomar medidas de protección adicionales de acuerdo con el manual de instalación. Todas las conexiones cableadas al producto deben estar en el mismo edificio. Si el

producto se instala fuera del perímetro del edificio o se utiliza en una aplicación en varios edificios, las conexiones cableadas se deben proteger contra sobretensión o corriente transitoria. Algo recomienda que la instalación de este producto la realice un electricista calificado.

Si usted no puede comprender la información de seguridad en inglés, comuníquese con Algo por correo electrónico para obtener asistencia antes de intentar instalarlo: support@algosolutions.com.

Wichtige Sicherheitsinformationen

Dieses Produkt wird durch eine zertifizierte Stromquelle mit begrenzter Leistung (LPS – Limited Power Source) betrieben. Die Stromversorgung erfolgt über Ethernet (PoE – Power over Ethernet). Dies geschieht durch eine Cat-5-Verbindung oder eine Cat-6-Verbindung zu einer IEEE 802.3af-konformen Ethernet-Netzwerkweiche. Das Produkt wurde konzipiert für die Installation innerhalb eines Gebäudes oder außerhalb eines Gebäudes. Bei der Anwendung außerhalb eines Gebäudes müssen zusätzliche Schutzmaßnahmen gemäß der Gebrauchsanweisung durchgeführt werden. Alle Kabelverbindungen zum Produkt müssen im selben Gebäude bestehen. Wenn das Produkt jenseits des Gebäudes oder für mehrere Gebäude genutzt wird, müssen die Kabelverbindungen vor Überspannung und Spannungssprüngen geschützt werden. Algo empfiehlt das Produkt von einem qualifizierten Elektriker installieren zu lassen.

Sollten Sie die englischen Sicherheitsinformationen nicht verstehen, kontaktieren Sie bitte Algo per Email bevor Sie mit der Installation beginnen, um Unterstützung zu erhalten. Algo kann unter der folgenden E-Mail-Adresse erreicht werden: support@algosolutions.com.

安全须知

本产品由认证的受限电源 (LPS)，以太网供电 (PoE)，通过CAT5或CAT6线路联接至IEEE 802.3af兼容的PoE网络交换机供电。本产品适用于室内或建筑物周边安装。如用于室外环境，必须按照安装手册采用附加的保护措施。所有联接本产品的线路必须源自同一建筑物。本产品如需用于超出建筑物周边范围或跨建筑物的安装，线路联接部分必须有过压和瞬态保护。Algo建议本产品由专业电工安装。

如果您对理解英文版安全须知有问题，安装前请通过电子邮件和Algo联系，support@algosolutions.com。

Important Safety Information



EMERGENCY COMMUNICATION

If used in an emergency communication application, the 8036 SIP Multimedia Intercom should be routinely tested. SNMP supervision is recommended for assurance of proper operation. Contact Algo for other methods of operational assurance including the use of the integrated microphone for automated "sound to air" acoustic testing.

WET OR OUTDOOR ENVIRONMENTS

The 8036 SIP Multimedia Intercom is intended for indoor or outdoor locations and may be subjected to spray or weather, provided the rear wiring cavity is properly sealed to prevent water ingress.

Gaskets included with the 8036 SIP Multimedia Intercom may be effective against water ingress on some, but not all surfaces in which case additional protective measures must be taken such as a perimeter sealant.

CAT5 or CAT6 connection wiring to an IEEE 802.3af compliant network PoE switch must not leave the building perimeter without adequate lightning protection.

When the Intercom is connected to wiring that exits the building, there is potential risk of lightning induced electrical surges or high voltages from fault conditions. To reduce risk, outdoor wiring should be protected by Earth grounded conduit whenever possible. Relay input and output connections must not leave the building perimeter without adequate lightning protection.

About the Algo 8036 SIP Multimedia Intercom

The 8036 is a multimedia SIP endpoint from Algo combining the functionality of an IP phone, security camera, and interactive kiosk. Easily configurable to support multiple applications and interface configurations, the product is designed for outdoor or public access locations to provide enhanced communication and support for guests and visitors.

The 8036 SIP Multimedia Intercom can be configured using central provisioning features or by accessing a web interface via browsers such as Google Chrome, Firefox, or Internet Explorer.

What is Included

- 8036 SIP Multimedia Intercom
- Network Cable
- Mounting Gasket
- Drywall Bracket
- Surface Mount Bracket
- Algo Security Tool
- Ethernet Cable Boot
- 6 Type A Pan Head Phillips
- 6 Type B Pan Head Phillips

What is not Included

- Optional 8061 SIP Relay Controllers
- This Installation Guide (www.algosolutions.com/8036/guide)

Product Tour

Front View

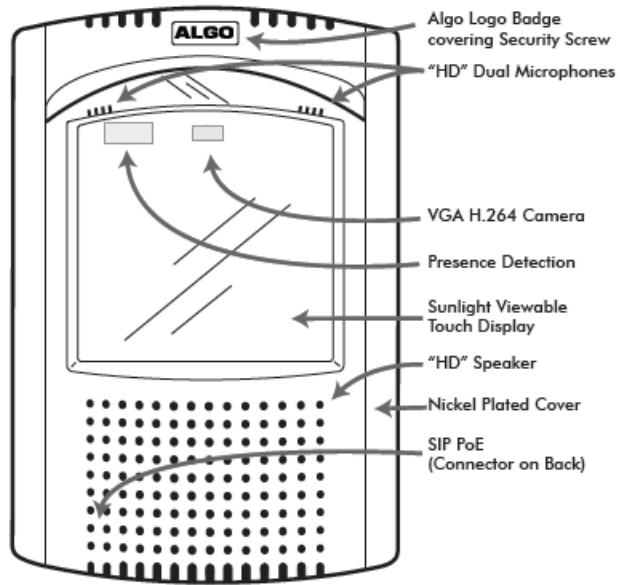

Back View (of 8036 Assembly)

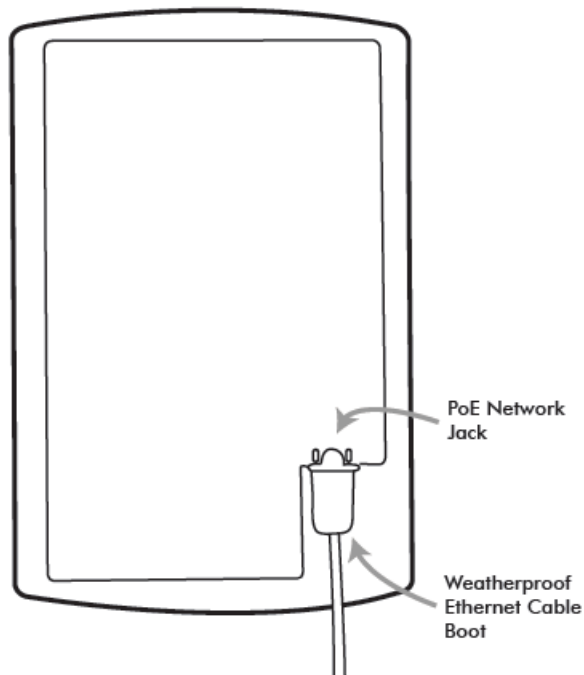

Getting Started - Quick Install & Test



This guide provides important safety information which should be read thoroughly before permanently installing the Intercom.

1. Connect the 8036 SIP Multimedia Intercom to an IEEE 802.3af compliant PoE network switch. The LCD screen will turn on and the 8036 will display the IP address on the screen. If the 8036 is unable to obtain an IP address from the DHCP server, it will default to the fixed IP address 192.168.1.111. The IP address may also be discovered by downloading the Algo locator tool to find Algo devices on your network: www.algosolutions.com/locator
2. Access the 8036 SIP Multimedia Intercom web page by entering the IP address into a browser (Chrome, IE, Firefox, etc.) and login using the default password **algo**.
3. Enter the IP address for the SIP server into the SIP Domain field under the **BASIC SETTINGS > SIP** tab.
4. Enter the page SIP Extension, Authentication ID, and Password.
Note: The Authentication ID may also be called Username for some SIP servers, and in some cases may be the same as the SIP extension.
5. For basic testing, create a UI test screen with a Call Button:
 - a. In the **User Interface > General** tab select 1 for the "Number of Active Pages" and click "Save" at the bottom right corner, to see the new "Page 1" appear in the tabs area. The 8036 screen should also now display a default image of a sky with clouds.
 - b. Proceed to the new "Page 1" tab and choose the "Button" template.
 - c. Choose "Single Button" for the "Button Layout" field.
 - d. Give the new Button 1 a name in the "Text" field (e.g. "Dial and Extension"). Pick the "Call" action for Button 1 and enter the extension you would like to dial from the intercom.
 - e. After saving the page, the new button should appear on the 8036 screen.
6. Press the Call Button on the 8036 Intercom screen, then answer the phone to talk over the Intercom.

Installation

This section will guide you with the physical installation of your new 8036 SIP Multimedia Intercom.

Wall Mounting

The 8036 can be either surface or flush mounted. The unit is designed to shed rainwater and allow air ventilation only when oriented in the correct position (ALGO logo at top) and installed vertically.

Removal of Front Bezel for Installation

The 8036 is shipped partially assembled and must be partially disassembled before it can be installed.

Remove the security screw behind the ALGO Logo Badge by first pressing on one side of the badge. This will raise the other side so that it can be removed easily by hand.

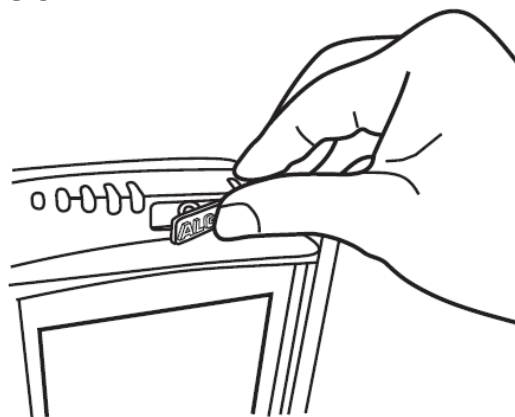

A security bit ("Algo Security Tool") is included with the 8036 that fits standard socket screwdrivers. Use the bit in a screwdriver to remove the security screw and carefully remove the Front Bezel by pulling at the top and then disengaging the bottom clip.

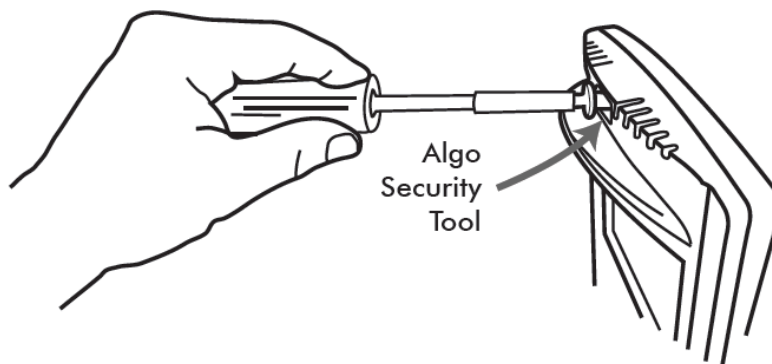

Put the Front Bezel, Security Screw, and Logo Badge aside for re-assembly after mounting.

Refer to the following diagrams for the appropriate methods and components to use for different mounting applications.

Flush Mounting into Drywall (Interior)

1. Create a drywall cut out. The template that can be downloaded at: www.algosolutions.com/8036mounting
2. Place the Drywall Bracket into wall and bend tabs around to the front of the drywall to hold in place.
3. After connecting the Ethernet cable, use the #8 x 1.5" Type A Pan Head screws to secure the 8036 housing to the Drywall Bracket.
4. Replace the Front Bezel and keep the Algo Security Tool in a safe location.
5. Replace the ALGO Logo Badge.

Note: The Mounting Gasket and Surface Mount Bracket are not required for drywall mounting.

Flush Mounting an 8036 into an interior wall (drywall)

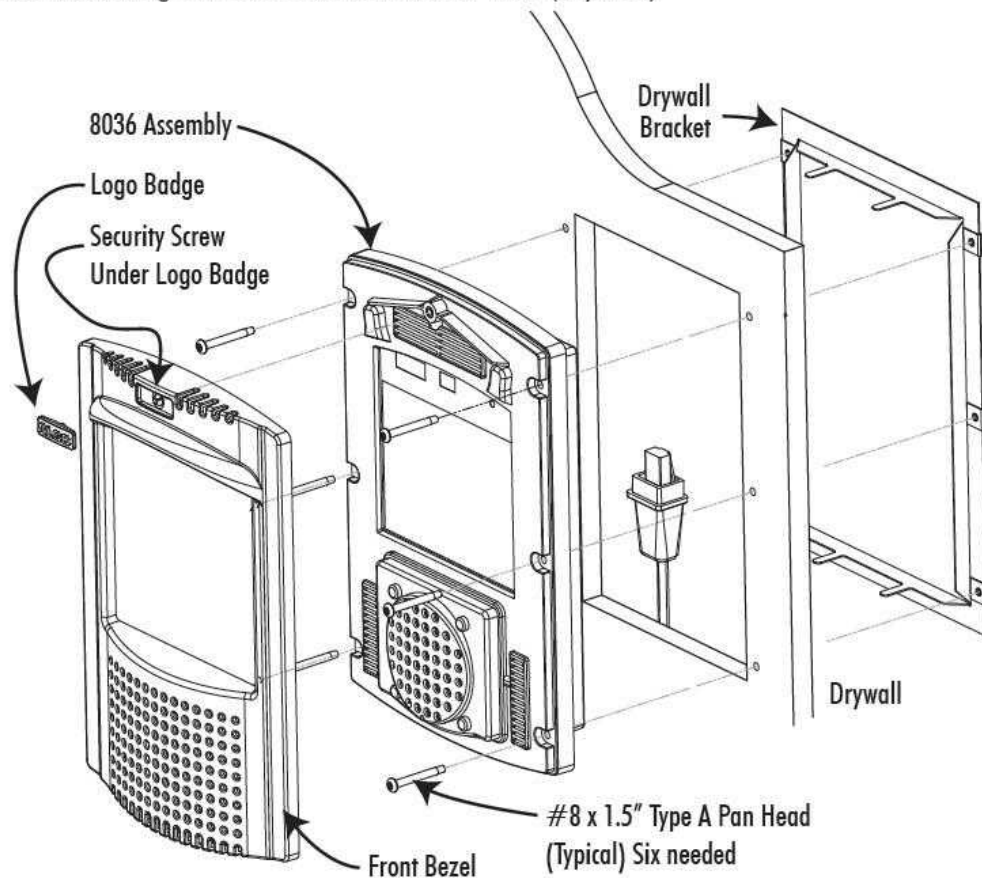

Flush Mounting into Other Materials or Outdoors

The same guidelines of flush mounting from the previous section apply, however, the Drywall Bracket may not be required if the wall material is firm enough to hold a screw close to the cut out edge. A #8 anchor may be required (not supplied) for the wall material.

If outdoors:

1. Create a drywall cut out per the template found at www.algosolutions.com/8036mounting. A rubber Ethernet Cable boot is supplied to be placed over the network cable prior to terminating with a plug (see "PoE Network Connection" on page 15).
2. While the 8036 is designed to withstand rain, it may be undesirable for water to enter the wall cavity. This can be achieved by sealing the cable hole prior to mounting or using the Mounting Gasket between the 8036 and wall. Uneven surfaces may require a silicon bead around the 8036 after installation.

Flush Mounting an 8036 into Drywall

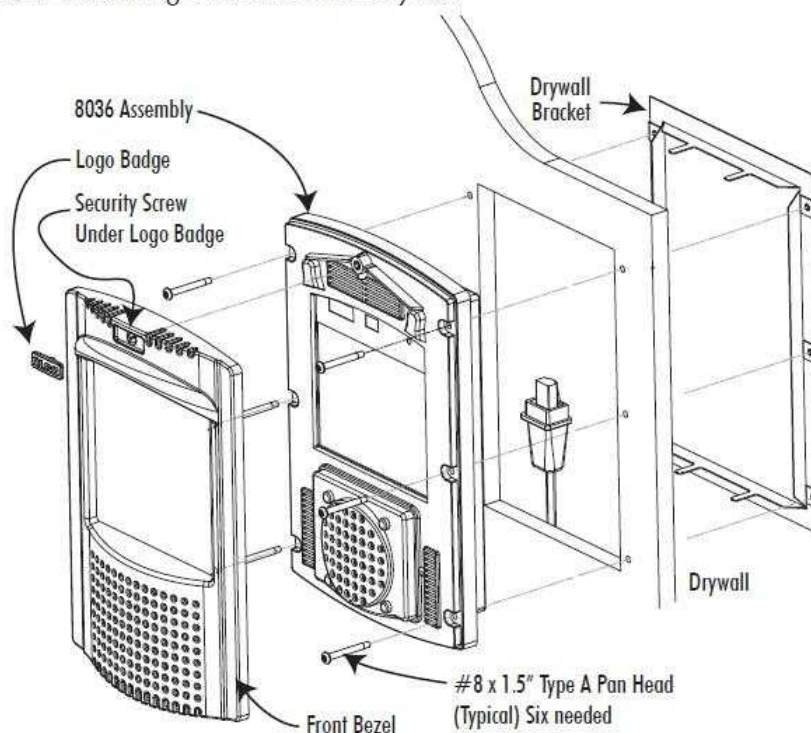

Flush Mounting an 8036 into Drywall

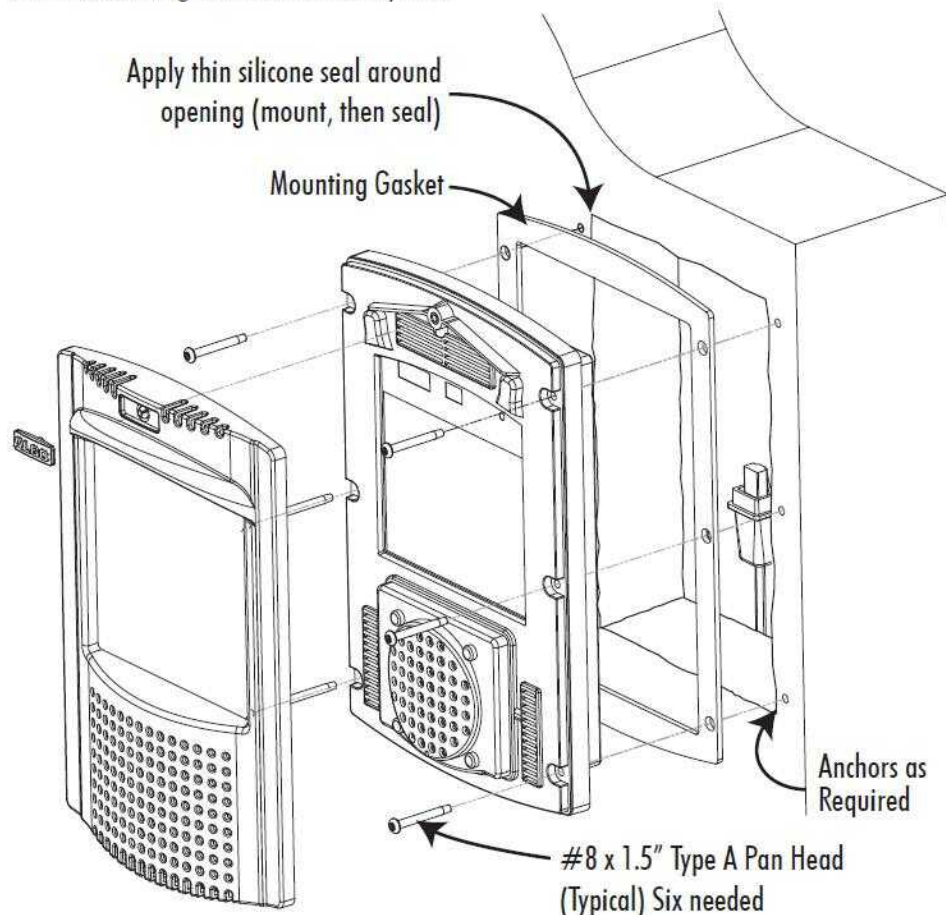

Surface Mounting

The Surface Mount Bracket may be used on a wall surface where flush mounting is undesirable, or not practical. The bracket also may be good option when integrating the 8036 into stonework.

1. Mount the Surface Mount Bracket using the #8 x 1.5" Type A Pan Head screws supplied. For some wall materials, #8 anchors may be required (not included).

If outdoors:

- a. Ensure any opening in the wall is sealed or apply a silicon bead between the Surface Mount Bracket and wall surface around the outside perimeter.

- b. The Ethernet Cable Boot is to be placed over the network cable prior to terminating with a plug (see "PoE Network Connection" on page 15).
 - c. To prevent water from getting behind the 8036, place the Mounting Gasket on to the 8036 housing prior to mounting.
2. After connecting the Ethernet cable, use the #8 x 1" Type B Pan Head screws to secure the 8036 housing to the Surface Mount Bracket.
3. Replace the Front Bezel and keep the Algo Security Tool in a safe location. Replace the ALGO Logo Badge.

Note: The Drywall Bracket is not required when surface mounting.

Surface mounting an 8036 on outside wall

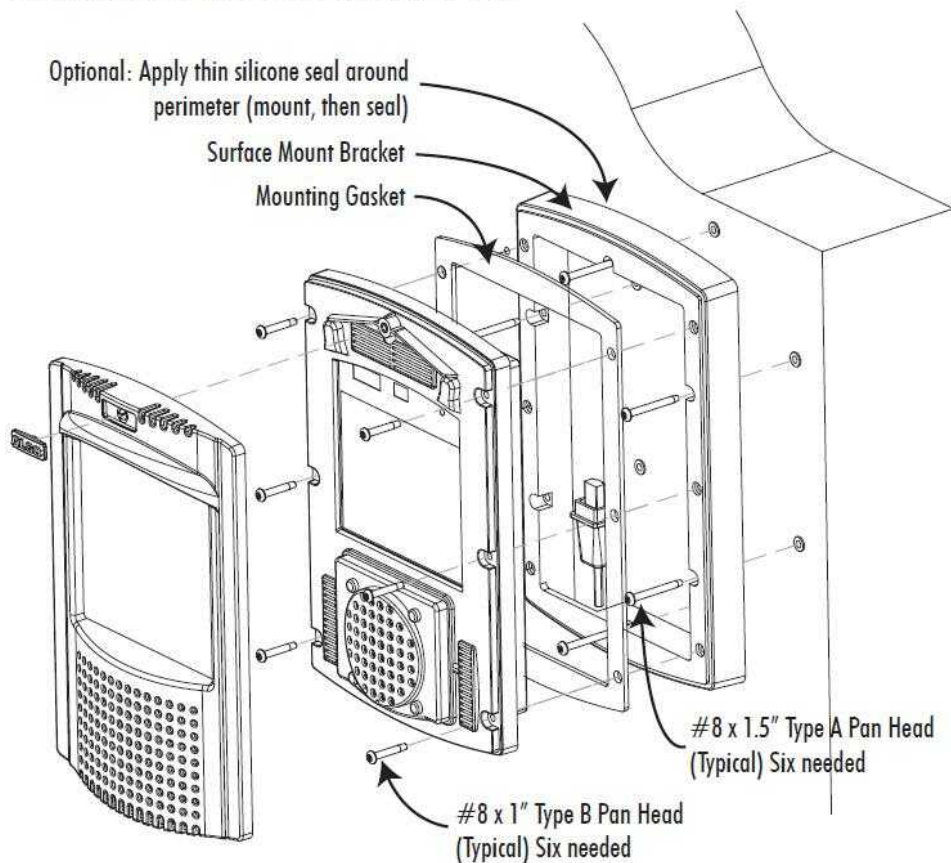

Mounting Height

The 8036 should be mounted at an appropriate height for your intended application. The considerations are:

1. Easy readability of the interface screens for users of different heights.
2. Highest quality camera and video images.

For most applications, a mounting height of approximately 55 inches (1.4 m) from floor to center of display is recommended.

Mounting the 8036 at the proper height

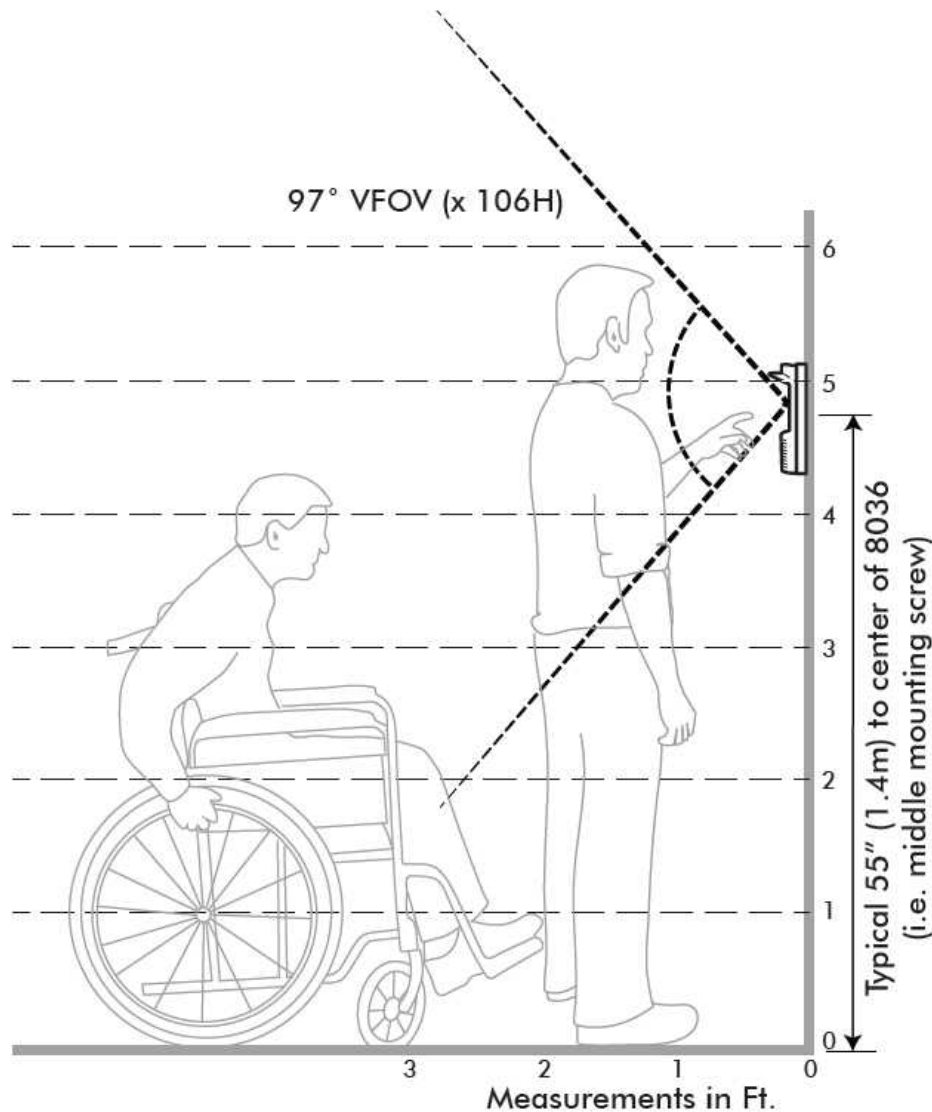

PoE Network Connection

The 8036 is powered by the Ethernet PoE network connection. Typically a network cable is run to the 8036 location and then terminated with a male RJ45 plug.

If you don't have a PoE switch, you'll need a PoE injector that installs between the 8036 and the network switch. The PoE injector will supply 48 Vdc to the 8036. Ensure that the PoE injector is fully compliant to the IEEE 802.3af standard.

If mounting outdoors, slide the Ethernet Cable Boot onto the cable before installing the RJ45 plug.

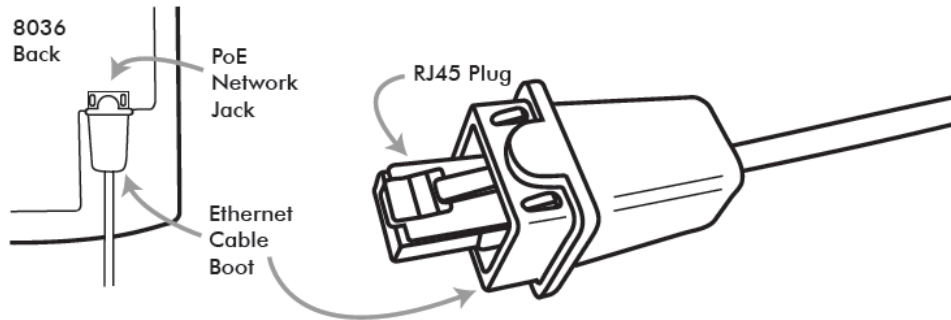

After inserting the plug into the 8036 jack, carefully position the boot into the jack cavity to prevent moisture or insects from getting inside.



When inserting the plug into the jack, be sure the plug lock tab is not accidentally depressed, creating a loose connection.

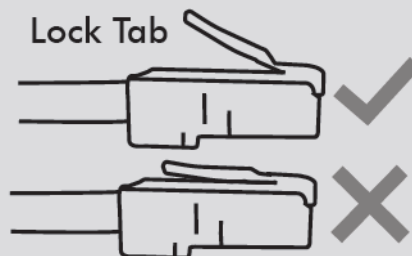

Web Interface

Primary configuration of the 8036 is through the web interface control panel. Here is where you will be able to set up your 8036 and also develop interface screens to create interactive applications.

Accessing the Control Panel

To access the 8036 Control Panel, your first need to determine the 8036's IP address and then enter this address into a browser.

Finding the IP Address

After connecting the 8036 to a network PoE port, the 8036 will attempt to obtain an IP address from the DHCP server and display this on the screen.



If this is the first time you are using the 8036 and no user interface has yet been set up, you will be displayed the Welcome screen to the right which provides the IP address. If a User Interface already exists, the IP address will be shown for a few seconds at boot time, before the splash screen appears.

If the 8036 is unable to obtain an IP address from the DHCP server, it will default to the fixed IP address 192.168.1.111.

The IP address may be discovered by downloading the Algo locator tool to find Algo devices on your network:

www.algosolutions.com/locator

Enter the IP address (eg. 192.168.1.111) into a browser such as Google Chrome, Firefox, or Internet Explorer (other than IE9). The web interface should be visible and the default password will be **algo** in lower case letters.

Application Development

Overview

With the 8036 you can easily design, implement, and update custom user interface screens and functions that help you communicate most effectively with visitors and guests. For example, you can make attractive landing pages with your company logo and graphics. On it, you can have buttons that make calls or that lead to various information or directory pages.



Example 8036 Custom Graphics Screen using 3x3 Full Button layout with three active buttons.

You can set all of this up using the 8036 Control Panel. You'll also be able to back up all the configuration and user interface information to a PC for safekeeping.

Creating User Interface Screens

The key to an effective implementation of the 8036 is to configure a package of interface screens that fulfill the various visitor functions you require. You do this easily through the "User Interface" menu in the 8036 Control Panel (see "User Interface" on page [36](#)).

For a basic implementation, you can set up simple screens and pages using the generic button graphics and background screens provided with the system. You can also easily create graphics screens with standard image editing programs and then import them into the 8036. Either way, you can set up multiple pages with different button configurations and layouts, enable or disable specific button locations, and set different actions associated with each button.

You can also import tab-delimited text files containing names and numbers and have the 8036 display a directory whereby visitors can call individuals directly.

Custom Graphic Screens

To develop custom interface screens you need to be able to create 640 x 480 pixel graphic files in the PNG, GIF, and JPEG formats. Most graphics/image editing programs (such as Adobe® Photoshop®) have this capability. Within the graphics program you can create your own background and button graphics and then align the button graphics (if used) to the layouts you have chosen for your 8036 User Interface. Photoshop button layout templates are available for download at www.algosolutions.com/8036templates. For more information see page [39](#).

Directory (Addressbook) Listings

You can also upload tab-delimited text files to allow the 8036 to display directory pages. You can then set up pages to use these directory files to display a call directory for visitors to use. For more information see page [43](#).

Uploading user content

Before configuring a custom user interface, all the images, directory text files, and other resources that will be used by your UI must first be uploaded to the 8036. For information about uploading files, see the File Manager information on page [45](#).

Reset

A soft reset of your 8036 may be necessary if, for example, the administrative password has been changed and then forgotten.

To do a soft reset:

1. Disconnect the network cable from the 8036 and reconnect it again.
2. Press the words "**Algo 8036 Firmware: 1.5.1**" within five seconds of their appearance in the top middle section of the screen (see right). A confirmation button will appear in the bottom middle area with the text description "**Press here to reset to factory default.**"
3. Press this confirmation button within five seconds, and the unit will reset itself back to factory default settings.

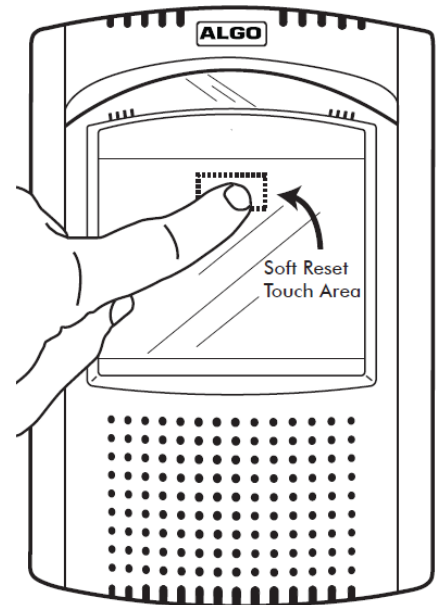

Web Interface Login

The web interface requires a password which is "**algo**" by default. This password can be changed using the *Admin* tab after logging in the first time.

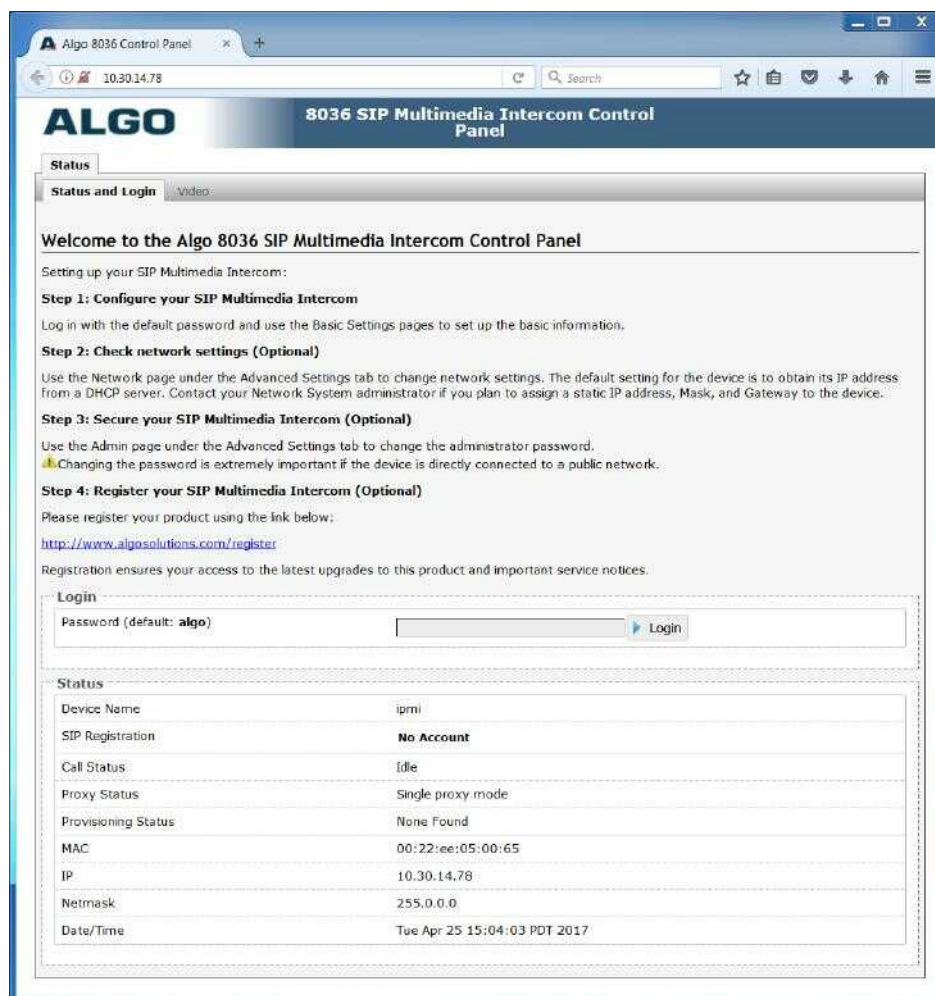

Status

The device's Status page will be available before and after log on. The section can be used to check 8036's SIP Registration status of the SIP extension, Call Status, Proxy Status, and general MAC, IP, Netmask, Date/Time information.

Status Tab – Video

The video can be seen in the "Status > Video" tab when the user is not logged in. A separate video password can also be enabled, to allow users to access the video, but not the rest of the device settings. This password can be set in "Basic Settings > Video" tab, "Session Passcode" field. Video settings like brightness, contrast are also available in the "Basic Settings > Video" tab.

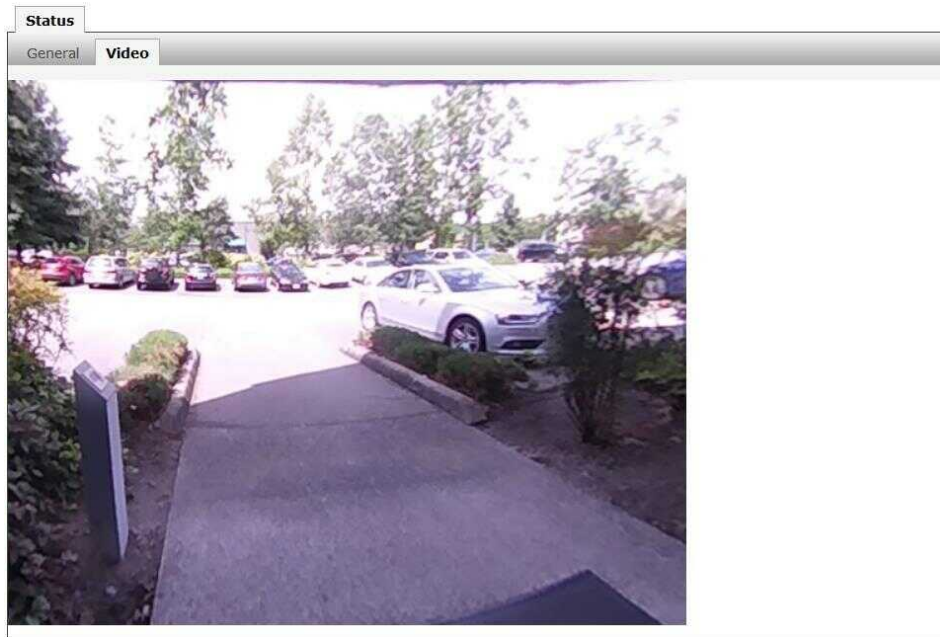

Basic Settings Tab – SIP

SIP Server information and Credentials should be obtained from your telephone system administrator or hosted account provider. After saving the settings, see the Status tab to confirm the registration was successful.

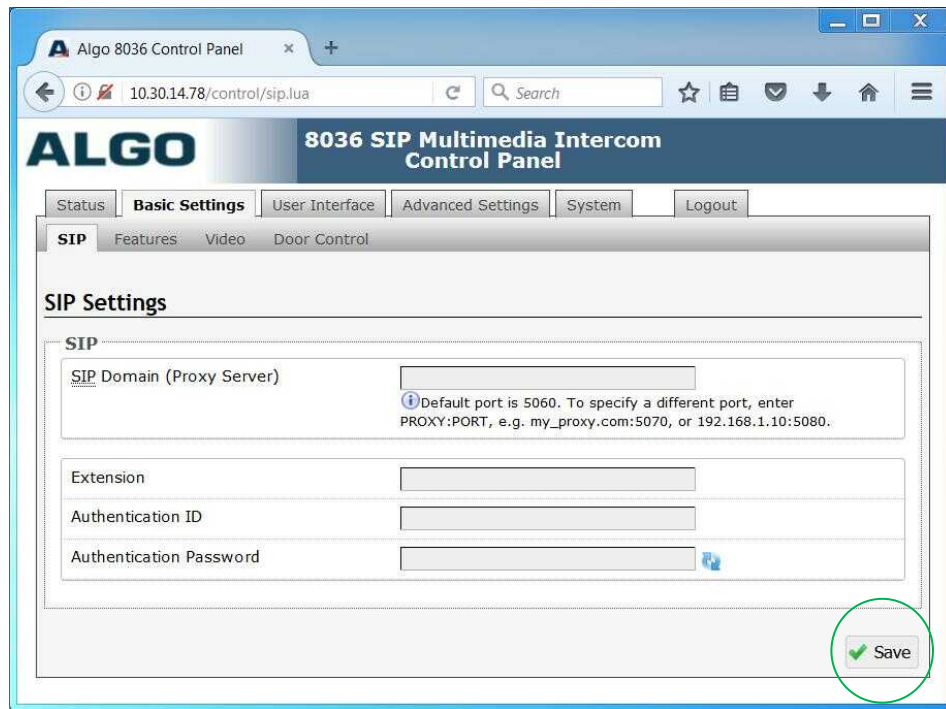

Note: Any time changes are made to settings in the Web Interface the "Save" key must be clicked to save the changes

SIP Domain (Proxy Server)

SIP Server Name or IP Address

Extension

Used to register the 8036 on the SIP Server.

Authentication ID

May also be called Username for some SIP servers, and in some cases may be the same as the SIP extension.

Authentication Password

SIP password provided by the system administrator for the SIP extension.

Basic Settings Tab – Features

The screenshot shows the 'Basic Settings' tab with the 'Features' sub-tab selected. The 'Features' section is divided into four main areas:

- Audio:** Speaker Volume (8), Microphone Volume (High), and UI Volume (4). Each has an 'Apply' button.
- Inbound Call:** Answer Inbound Call (Enabled), Answer Tone (<Default>).
- Outbound Call:** Outbound Ring Limit (5 rings), Ringback Tone (<Default>).
- Call Features:** G.722 Support (Enabled), Maximum Call Duration (None).

A 'Save' button is located at the bottom right of the configuration area.

Speaker Volume

Select speaker audio level from 1 (lowest) to 10 (highest).

Microphone Volume

Select the microphone volume of the 8036.

UI Volume

The 8036 provides click sounds to provide users with audible feedback to assure them their key presses were registered. You can adjust the sound volume for these feedback sounds from Mute to 10 (loudest).

Answer Inbound Call

Allows the doorphone to auto-answer when it receives an inbound call. *Ensure the device cannot be called from an external number, allowing for unauthorized access.*

Outbound Ring Limit

Typically set to ensure that a call will not reach voicemail. This feature can be used to set a limit on how long the 8036 speaker will ring before timing out.

Ringback Tone

Allow audible ringback tone to be played on the 8036 speaker until the call is answered.

G.722 Support

Enable or disable the G.722 codec.

Maximum Call Duration (Inbound/Outbound Calls)

Select the maximum call length. The call will be terminated once the maximum time is reached. In the event that a call inadvertently reaches voicemail or gets accidentally left on hold, this setting ensures that the 8036 returns on-hook.

Basic Settings Tab - Video

Status
Basic Settings
User Interface
Advanced Settings
System
Logout

SIP
Features
Video
Door Control

Video

⚠ Changing settings on this page will terminate any active call.

Mode

Video Call Mode One-way (Outgoing Only) Two-way

H.264

Profile Level

Packet Type

Quality Control Method Constant Bitrate Constant Quality

Maximum Bandwidth

QP Min

QP Max

Camera Settings

Auto White Balance Enabled Disabled

Exposure Compensation
ⓘ Bias the default auto-exposure algorithm to always be brighter or darker.

Manual Exposure Override Enabled Disabled
ⓘ Enables DTMF controls on the answering phone to modify the video exposure (brightness) during a call. Press the '3' key on the answering phone to make the image brighter, or the '2' key for darker.

Powerline Frequency

SIP Video Settings

Request Media Bandwidth Enabled Disabled

SIP Video Stream
ⓘ This controls the actual video stream sent by the 8036.

Web Video Settings

Maximum Browser Sessions

Session Passcode
ⓘ This allows a separate password to be configured that allows access to only the "Status > Video" tab.

Web Video Resolution

Save

Video Call Mode

Select video call mode:

- One-way Video (outgoing only):** The 8036 only sends video to the remote end (eg. a video phone). It does not show any video on the 8036 itself. Two-way audio is still maintained in this configuration.

- **Two-way Video:** Video communication in both directions if remote end supports video.

Profile Level

Refer to phone specifications to determine best supported profile level ("1.3 Baseline" or "3 Baseline").

Packet Type

Refer to phone specifications to determine best supported packet type ("Single NAL Unit" or "Fragmentation Unit Type A (FU-A)").

Quality Control Method

Select method:

- **Constant Bitrate:** Allows modification of video parameters at constant bitrate: Maximum Video Bandwidth, QP Min, and QP Max.
- **Constant Quality:** Allows PQ value (default: 28) modification, given constant video quality.

Maximum Bandwidth

Set a signal capacity for video content transmission.

QP Min

Minimum Quantization Parameter for H.264 level. (Default: 20)

QP Max

Maximum Quantization Parameter for H.264 level. (Default: 31)

Auto White Balance

Enable or disable Auto White Balance.

Exposure Compensation

Bias the default auto-exposure algorithm to always be brighter or darker.

Manual Exposure Override

When "Enabled" allows DTMF controls on the answering phone to modify the video exposure (brightness) during a call. Press the '3' key on the answering phone to make the image brighter, or the '2' key for darker.

Powerline Frequency

Choose the local powerline frequency. For example, 60 Hz in North America and 50 Hz in Europe.

Request Media Bandwidth

Enable or disable as required by the far-end phone.

SIP Video Stream

This controls the resolution of the actual video stream sent by the 8036.

Maximum Browser Sessions

Allows for a limit to be set on the number of separate browser sessions that can be open simultaneously to show the video. The setting can be "Disabled" to turn off the web video capability.

Session Passcode

Allows a separate password to be configured that allows access to only the "Status > Video" tab.

Web Video Resolution

This controls the resolution of the web video.

Basic Settings Tab – Door Control

The 8036 can be configured with up to four optional 8061 IP Relay Controllers to provide door control and security for up to four doors. Each 8061 allows one door to open via a pre-configured "Door Access Keypad" on the 8036. Each "Door Access Keypad", in turn allows multiple codes (e.g. visitors, employees, etc.) to be configured for its associated door. This application is useful in places like lobbies with up to four separate businesses/units each requiring secure codes to open that businesses' or unit's locked door.



Status	Basic Settings	User Interface	Advanced Settings	System	Logout
SIP	Features	Video	Door Control		
Network Door Controller Settings					
<p>i This section allows security codes to be configured for unlocking the door. There are two different ways to unlock the door:</p> <ul style="list-style-type: none"> From inside the building: using the DTMF keypad on the inside telephone that answers the call ("Inside Codes") From outside the building: using the keypad on the doorphone touchscreen ("Outside Codes") <p>i An electronic doorstrike is required for unlocking the door. These doorstrikes typically require their own power system and a contact closure for activation. For security purposes, the contact closure is not provided on the 8036. Instead, a Network Door Controller (Algo 8061, sold separately) is used, located securely inside the building.</p>					
General					
Number of Network Door Controllers	1				
Door Unlock Tone	<input type="radio"/> Enabled <input checked="" type="radio"/> Disabled				
#1 Network Door Controller					
Address	<input type="text"/>				
	i Requires Algo 8061, firmware v2.7.3 or above.				
Password	<input type="password"/>				
Inside Codes Door Unlock via Telephone DTMF.					
Momentary Open Code	6 <input type="text"/>				
	i 1-4 digit code that can be used to unlock the door for a brief period of time (as set by the Duration field). Leave this field blank to disable this feature.				
Duration	3 seconds				
	i The duration for which to unlock the door when the MomentaryOpen Code is entered.				
Latch Open Code	<input type="text"/>				
	i 1-4 digit code that can be used to unlock the door indefinitely. Leave this field blank to disable this feature.				
Latch Closed Code	<input type="text"/>				
	i 1-4 digit code that will lock the door again when it is latched open. Leave this field blank to disable this feature.				
Outside Codes Door Unlock from Doorphone Touch Screen Keypad.					
Access Code	<input type="text"/>				
	i Max 8 digits for each code. Separate codes with space, comma or semicolon. Blank means disabled.				
<input checked="" type="checkbox"/> Save					

Number of Network Door Controllers

Select up to 4 optional 8061 IP Relay Controllers to configure.

For 8061 IP Relay Controller configurations, see page [66](#).

Door Unlock Tone

A sound can be played when a door is open, to create awareness.

Address

IP address of an 8061 IP Relay Controller.

Password

Used to authenticate the link between the 8036 and the 8061 IP Relay Controller. Ensure that the two devices have matching passwords. Default password is **algo**.

Note: the Password is used solely to secure the link between the 8036 and the 8061. It is not the same as the Momentary Open Code.

Momentary Open Code

Enter a 1-4 digit DTMF code (default 6) that can be used to unlock the door for a brief period of time. Leave this field blank to disable this feature.

Duration

The duration for which to unlock the door when the Momentary Open Code is entered. From 1/4 to 30 seconds.

Latch Open Code

Enter a 1-4 digit DTMF code that can be used to unlock the door indefinitely. Leave this field blank to disable this feature.

Latch Closed Code

Enter a 1-4 digit DTMF code that will lock the door again when it is latched open. Leave this field blank to disable this feature.

Access Code

Enter a 1-8 digit numeric code that can be used, from the touch screen, to unlock the door for a brief period of time. *Multiple codes* can be entered by separating each code with a space, comma, or semicolon. Typically used for employee/tenant access. Leave this field black to disable this feature.

User Interface Tab – General

Status Basic Settings User Interface Advanced Settings System Logout

General Page 1 - Home Page 2 - Directory Page 3 - Sample Name File Manager

General Settings

Global Settings

Number of Active Pages	3	Number of configurable pages that will be created as part of the User Interface.
Home Page	Page 1 - Home	User interface starts with this page.
Default LCD Brightness	8	Screen backlight brightness.
Door Unlock Message	<input type="radio"/> Enabled <input checked="" type="radio"/> Disabled Display a message when door is open using DTMF.	

Timeout Settings

User Interface Timeout	5 seconds	The User Interface can dim or activate a slideshow after a period of inactivity.
Timeout Action	Activate Slideshow	
Action on Resume	Return to Previous Page	
LCD Brightness after Timeout Event	<Default>	

Presence Detection Settings

Presence Sensor for User Interface	<input checked="" type="radio"/> Enabled <input type="radio"/> Disabled Detects when a visitor is present within 80cm directly in front of the screen. Will cancel the slideshow or screen dimming if these features are active.
Action when Presence Detected	Call Automatically initiates a phone call when a visitor is detected.
Extension to Dial	<input style="width: 100%;" type="text"/>

Slideshow Settings

A slideshow allows a series of images to be played in sequence. The slideshow can be activated after a period of inactivity (using the Timeout settings above), or directly from a button press. Use the [File Manager](#) tab to upload images to the "slides" folder. Images must be 640x480 resolution, in PNG, JPG, or GIF format. The slideshow can be exited by a touchscreen press, or by the presence detection sensor (see settings above).

Interval between Slides (seconds)	5	Valid value is between 0 and 300 (5 minutes).
-----------------------------------	---	-----------------------------------------------

Call Control Settings

Hangup Button	<input checked="" type="radio"/> Enabled <input type="radio"/> Disabled Displays a "Hangup" button on the screen during a phone call to allow the visitor to end this call
Action at End of Call	Return to Previous Page

Save



Number of Active Pages

Select the number of configurable pages that will be created as part of the User Interface. A new "Page #" tab will appear in the tabs area. These do not apply to Dial Keypads and Access Keypads.

Home Page

Select an active page to be displayed as the start page of the 8036 User Interface.

Default LCD Brightness

Set the default LCD screen brightness, from 1 (lowest) to 10 (highest).

Door Unlock Message

If "Enabled" a door unlocked message will be displayed on the 8036 screen when the door is open via DTMF.

User Interface Timeout

Set the maximum idle time after which the current 8036 display screen returns to default (see "Timeout Action" below).

Timeout Action

Select an action to take place after the User Interface Timeout period.

- **None** - allows the 8036 to indefinitely display the recently accessed page.
- **Go to Homepage** - returns the display screen to the start page.
- **Activate Slideshow** - loops through the images uploaded in the "slideshow" folder found in User Interface > File Manager tab (see page 45 for details). Time between slides can be set in the "Interval between Slides" setting below.
- **Turn off LCD** - powers the screen off until 8036 is accessed again.

Slideshow and screen dimming actions can be cancelled by either touching the 8036 screen or by enabling the "Presence Sensor for User Interface."

Action on Resume

Select whether the 8036 screen should "Return to Previous Page" or "Go to Homepage" when the 8036 User Interface is accessed again after a slideshow or screen dimming.

LCD Brightness after Timeout Event

Specify LCD screen brightness after the "User Interface Timeout." "Default" maintains the same screen brightness as set for "Default LCD Brightness" setting above.

Presence Sensor for User Interface

When "Enabled", 8036 detects a visitor presence within 80cm directly from the screen, cancelling the slideshow or screen dimming actions, if enabled.

Action when Presence Detected

If desired, select an additional action, like "Call" and extension, to take place when a presence is detected.

Interval between Slides (second)

Enter the time (seconds) between slides in the slideshow. The range is 0 – 300 seconds (5 minutes).

Hangup Button

When "Enabled", 8036 displays a "Hangup" button on the screen during a phone call to allow the visitor to end the call.

Action at End of Call

Choose the 8036 screen to "Return to Previous Page" or "Go to Homepage" after the call to/from the 8036 unit ends.

User Interface Tab – Page (Button Template)

There are seven button layouts (up to 9 buttons) that can be configured on an 8036 screen.

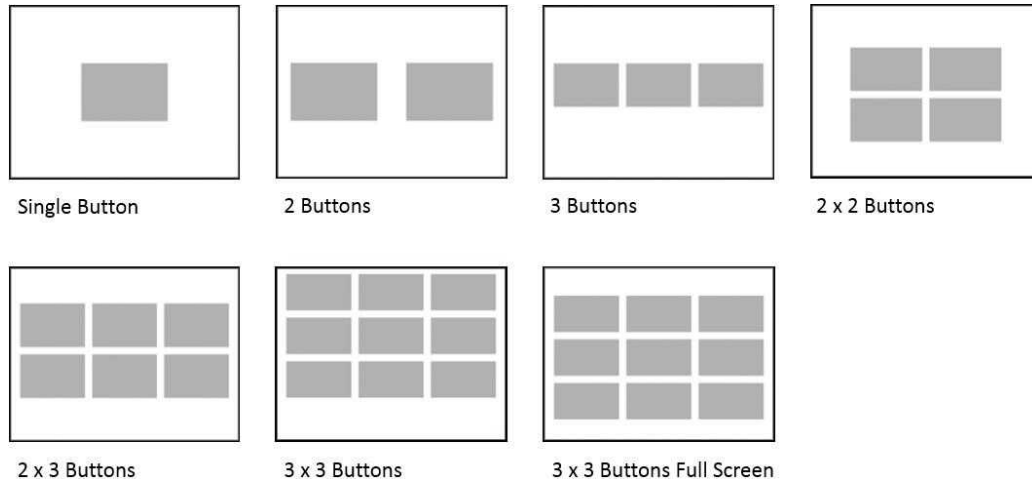

Note: The 3 x 3 Buttons layout is similar to 3x3 Full Screen layout below but has extra space at bottom to allow the unobstructed use of the "Home" and "Back" buttons.

The chosen layout can be customized further by enabling/disabling the appearance/activation of specific buttons on the 8036 screen. For instance, to display 3 vertical buttons in the first column, only the appropriate buttons should be activated: 

Custom Graphics and Backgrounds

Custom graphic screens with buttons, that line up to the pre-configured 8036 screen, can be created using Photoshop templates available for download at www.algosolutions.com/8036templates. For best appearance on the screen, the files should be 640 x 480 pixels, 16 bit high color, and in PNG, JPEG, or GIF format. Files of other sizes will be automatically shrunk/expanded to fit the screen. The graphics can be uploaded to the "background" folder in the User Interface > File Manager tab (see page [45](#)).

For more information about button layouts and their pixel locations please see page [67](#).

Status Basic Settings **User Interface** Advanced Settings System Logout

General **Page 1** File Manager

Page Settings

General

Template Button Directory

Description

Button Page

Background (user) test.png

Button Layout 3x3 Buttons

Back Button Enabled Disabled

Home Button Enabled Disabled

Action on Background Touch Event (outside of buttons) None Call Go to Page

Button 1 Enabled Disabled

Text Staff Access

Action None Call Go to Page

Action - Target Page Door Access Keypad 1

Button 2 Enabled Disabled

Text Visitors

Action None Call Go to Page

Action - Target Page Dial Keypad

Button 3 Enabled Disabled

Text Reception

Action None Call Go to Page

Action - Call Destination 3435

Button 4 Enabled Disabled

Button 5 Enabled Disabled

Button 6 Enabled Disabled

Button 7 Enabled Disabled

Button 8 Enabled Disabled

Button 9 Enabled Disabled

Save

Template

Choose a display screen/page type: "Button" or "Directory".

Description

Enter a page description (optional). This description will be seen in the button "Target Page" drop down menus as well as the web interface tabs.

Example:

Status Basic Settings **User Interface** Advanced Settings System Logout

General **Page 1 - Home** Page 2 - Directory Page 3 - Sample Name File Manager

Background

Set a background image for the screen. Several standard options have been supplied and are marked by "(default)" tag. Uploaded custom graphics will be preceded with "(user)" tag. For more information about uploading the graphics see page [45](#).

Button Layout

Select the touch screen button layout for button settings to appear below.

Action on Background Touch Event (outside of buttons)

Select an action to take place when an area outside the button is pressed. This option can be used when custom graphics display messages like "Press anywhere to begin" or "Press anywhere to make a call". Active buttons can still be configured on the screen or they can be disabled.

Back Button

Adds a Back button to the lower left of the screen. Clicking it will return the user to the previously displayed screen. The Back button can be enabled or disabled.

Home Button

Adds a Home button to the lower right of the screen. Clicking it will return the user to the Home Page (eg. Page 1). The Home button can be enabled or disabled.

Button

Enable or disable specific buttons to be active and/or displayed on the 8036 screen.

Text

Sets the text with a default steel button to be displayed in the button location.

If using a custom graphic screen with existing buttons, leave this field blank.

Action

Specify whether you want the button to direct the user to a page/keypad or "Call" an extension.

Action – Call Destination

Displayed when Action Type is set to "Call". Enter the extension to be dialed after the button is clicked.

Action – Target Page

Displayed when Action Type is set to "Go to Page". Select the page/keypad to display after the button is clicked.

User Interface Tab – Page (Directory Template)

The screenshot shows a web-based configuration interface. At the top, there are tabs for 'Status', 'Basic Settings', 'User Interface', 'Advanced Settings', 'System', and 'Logout'. Below these, there are sub-tabs for 'General', 'Page 1', 'Page 2', and 'File Manager'. The main content area is titled 'Page Settings' and contains two sections: 'General' and 'Directory Page'. In the 'General' section, there is a 'Template' field with radio buttons for 'None', 'Button', and 'Directory' (which is selected). Below it is a 'Description' text input field. In the 'Directory Page' section, there is an 'Address Book File' dropdown menu currently showing 'sample1.txt'. A 'Save' button with a green checkmark is located at the bottom right of the form.

Directory (Addressbook) Text Files

Tab-delimited text files can be uploaded to the “addressbook” (in the File Manager) to display directory entries (see page 45). These entries can then be used by visitors to make calls to individuals listed in the file.

As an example, here is the contents of a directory file with two fields, one for “name” that will be displayed on the 8036 screen, and one for “telephone extension” that the 8036 will dial.

Al Smith	1028
Bob Johnson	2156
John Jones	2345
Paul Phillips	1287
Terry Stevens	1256
Vicky York	2546
Zoe Filmer	2334



Note: each line represents one directory member field and that a TAB separates each field value. Empty lines will result in empty entries in the Directory.

To create a tab delimited text file using Microsoft Excel:

1. Open your spreadsheet document go to the Windows/Office round button menu and choose Save As...
2. Change the "Save as type" or "Format" field to read: 'Text (Tab delimited)'.
3. Enter a name for the document and click Save.

The Addressbook entries should be sorted before upload to the 8036, as the device will not sort the entries in the file.

User Interface Tab – File Manager

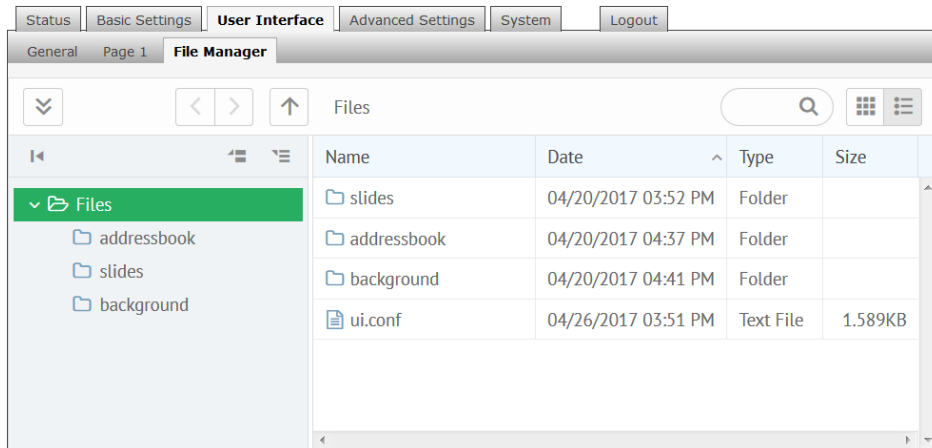

The custom slides, background images, and directory files should be uploaded to appropriate folders in the File Manager to be available when configuring the device.

Tab-delimited text files should be uploaded to the “addressbook” folder for directory entries (page 43). Images can be uploaded to either the “slides” folder, for slideshow displays (page 37), or “background” folder, for custom background screens (page 39). For best appearance on the screen, the image files should be 640 x 480 pixels, 16 bit high color, and in PNG, JPEG, or GIF format.

Note: the 8036 UI may need to be rebooted (in System > Maintenance tab) after uploading certain files (e.g. slides) in order for them to be visible on the screen.

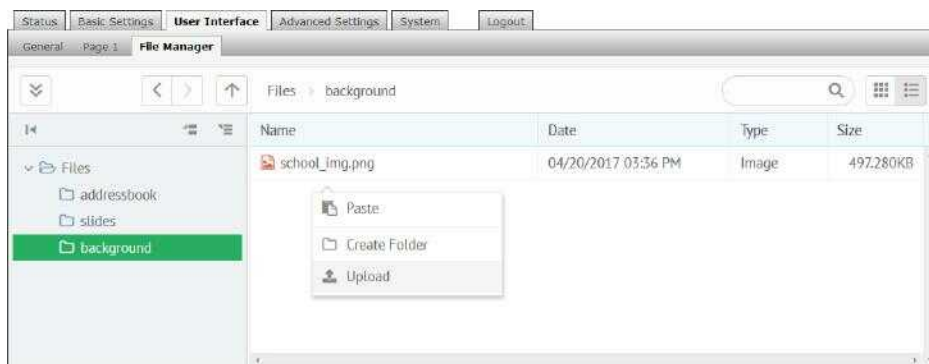

To upload a file, right-click in the appropriate folder for the menu to appear and select "upload" or "paste" if you are copying the file from another folder.

Multiple files can be uploaded simultaneously by holding the "Ctrl" or "Shift" key when selecting the desired files in the file viewer window.

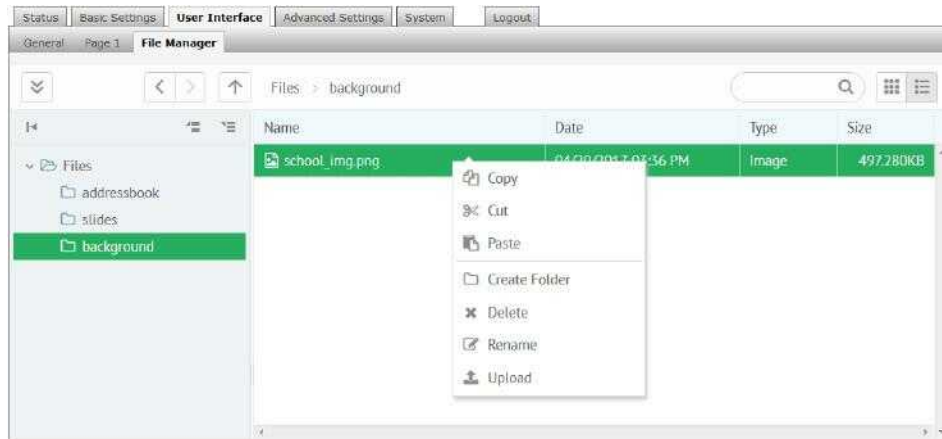

To delete, rename, cut/copy an existing file, right-click on the file of choice.

The 8036 UI can also be backed up and restored to/from a ZIP file in the System > Maintenance tab. See page [61](#) for more details.

Advanced Settings Tab - Network

Protocol

DHCP is an IP standard designed to make administration of IP addresses simpler. When selected, DHCP will automatically configure IP addresses for each 8036 SIP Multimedia Intercom on the network. Alternatively the 8036 SIP Multimedia Intercom can be set to a static IP address.

VLAN Mode

Enables or Disables VLAN Tagging. VLAN Tagging is the networking standard that supports Virtual LANs (VLANs) on an Ethernet network. The standard defines a system of VLAN tagging for Ethernet frames and the accompanying procedures to be used by bridges and switches in handling such frames. The standard also provides provisions for a quality of service prioritization scheme commonly

known as IEEE 802.1p and defines the Generic Attribute Registration Protocol.

VLAN ID

Specifies the VLAN to which the Ethernet frame belongs. A 12-bit field specifying the VLAN to which the Ethernet frame belongs. The hexadecimal values of 0x000 and 0xFFF are reserved. All other values may be used as VLAN identifiers, allowing up to 4094 VLANs. The reserved value 0x000 indicates that the frame does not belong to any VLAN; in this case, the 802.1Q tag specifies only a priority and is referred to as a priority tag. On bridges, VLAN 1 (the default VLAN ID) is often reserved for a management VLAN; this is vendor specific.

VLAN Priority

Sets the frame priority level. Otherwise known as Priority Code Point (PCP), VLAN Priority is a 3-bit field which refers to the IEEE 802.1p priority. It indicates the frame priority level. Values are from 0 (lowest) to 7 (highest).

Differentiated Services (6-bit DSCP value)

Provides quality of service if the DSCP protocol is supported on your network. Can be specified independently for SIP control packets versus RTP audio packets.

Advanced Settings Tab – Admin

The screenshot shows the 'Advanced Settings' tab with the 'Admin' sub-tab selected. The 'Admin Settings' section contains the following fields and options:

- Admin Password:** Password and Confirmation text input fields.
- General:**
 - Device Name (Hostname): ipmi
 - Introduction Section on Status Page: On Off
 - Web Interface Session Timeout: 1 hour (dropdown menu)
 - Play Tone at Startup: Enabled Disabled
- Log Settings:**
 - Log Level: Error (Lowest) Notice ("Event") Info ("SIP") Debug (Highest)
 - Log Method: Local Network Both
 - Log Server: (empty text field)
- Management:**
 - Web Interface Protocol: Both HTTP and HTTPS HTTPS Only
 - Force Strong Password: Enabled Disabled
 - Allow Secure SIP Passwords: Enabled Disabled
 - SNMP Support (v1 get only): Enabled Disabled

A 'Save' button with a green checkmark is located at the bottom right of the form.

Password

Password to log into the 8036 SIP Multimedia Intercom web interface. You should change the default password **algo** in order to secure the device on the network. If you have forgotten your password, you will need to perform a reset using the Reset Button in order to restore the password (as well as all other settings) back to the original factory default conditions.

For additional password security see "Force Strong Password" below.

Confirmation

Re-enter network admin password.

Device Name (Hostname)

Name to identify the device in the Algo Network Device Locator Tool.

Introduction Section on Status Page

Allows the introduction text to be hidden from the login screen.

Web Interface Session Timeout

Set the maximum period of inactivity after which the web interface will log out automatically.

Play Tone at Startup

A tone can be played at startup to confirm that the device has booted.

Log Level

Use on the advice of Algo technical support only.

Log Method

Allows the 8036 SIP Multimedia Intercom to write to external Syslog server if the option for external (or both) is selected.

Log Server

If "Network" or "Both" is selected this is the address of the Syslog server on the network.

Web Interface Protocol

HTTPS is always enabled on the device. Use this setting to disable HTTP. When HTTP is disabled, requests will be automatically redirected to HTTPS. Also note that since the device can have any address on the local network, no security certificate exists, and thus most browsers will provide a warning when using HTTPS.

Force Strong Password

When enabled, ensures that a secure password is provided for the device's web interface for additional protection. The password requirements are:

- Must contain at least 10 characters
- Must contain at least 1 uppercase character
- Must contain at least 1 digit (0 – 9)
- Must contain at least 1 special character

Allow Secure SIP Password

Allows SIP passwords to be stored in the configuration file in an encrypted format, to prevent viewing and recovery. Once enabled, the SIP "Realm" field should be entered and all the configured Authentication Password(s) must be re-entered in the Basic Settings > SIP tab, and any other locations where SIP extension have been configured, to save the encrypted password(s).

If the Realm is changed at a later time, all the passwords will also need to be re-entered again to save the passwords with the new encryption.

To obtain your SIP Realm information, contact your SIP Server administrator (or check the SIP log file for a registration attempt). The Realms may be the same or different for all the extensions used.

SNMP Support (v1 get only)

Additional SNMP support is anticipated for future, but the 8036 SIP Multimedia Intercom will respond to a simple status query for automated supervision. Contact Algo technical support for more information.

Advanced Settings Tab – Time

The screenshot displays the 'Time Settings' configuration page. At the top, there are navigation tabs: Status, Basic Settings, User Interface, **Advanced Settings**, System, and Logout. Below these are sub-tabs: Network, Admin, **Time**, Provisioning, Tones, and Advanced SIP. The main content area is titled 'Time Settings' and contains a 'General' section. This section includes a dropdown menu for 'Timezone' set to 'America/Los_Angeles', four text input fields for 'NTP Time Server 1' through '4' containing '0.debian.pool.ntp.org', '1.debian.pool.ntp.org', '2.debian.pool.ntp.org', and '3.debian.pool.ntp.org' respectively. Below these is the 'NTP Time Server Source' section with two radio buttons: 'Use DHCP Option 42' (selected) and 'Ignore DHCP Option 42'. A blue information icon and text state: 'By default, if an NTP Server address is provided via DHCP Option 42, this will be used instead of the options above.' At the bottom of the form, the 'Device Date/Time' is 'Wed Apr 26 15:11:48 2017' with a 'Sync with browser' button. A blue information icon and text state: 'Manual time and date are intended for testing purpose only. Time will be lost upon power down.' A green 'Save' button is located at the bottom right of the form.

Network time is used for logging events into memory for troubleshooting.

Timezone

Select timezone.

NTP Time Servers 1/2/3/4

The Intercom will attempt to use Timer Server 1 and work down the list if one or more of the time servers become unresponsive.

NTP Time Server Source

When "Use DHCP Option 42" is chosen, if an NTP Server address is provided via the DHCP Option 42, that NTP Server will be used instead of the 4 mentioned above. Alternatively, "Ignore DHCP Option 42" can be chosen to only use servers mentioned above.

Device Date/Time

This field shows the current time and date as set on the device. If testing the device on a lab network that may not have access to an

external NTP server, the "Sync with browser" button can be used to temporarily set the time on the device.

Note, this time value will be lost at power down, or overwritten if NTP is currently active. Time and date are used only for logging purposes and for the Scheduler.

Advanced Settings Tab – Provisioning

Provisioning allows installers to pre-configure 8036 SIP Multimedia Intercom units prior to installation on a network. It is typically used for large deployments to save time and ensure consistent setups.

Note: only the SIP and Network-related settings can be uploaded via Provisioning. The User Interface cannot be auto-provisioned at this time.

The device can be provisioned via the Auto mode (where all three DHCP options (Option 66/160/150) will be automatically checked for an active provisioning server), just one of the three specified DHCP options, or a Static Server. In addition, there are four different ways to download provisioning files from a "Provisioning Server": TFTP (Trivial File Transfer Protocol), FTP, HTTP, or HTTPS.

For example, 8036 configuration files can be automatically downloaded from a TFTP server using DHCP Option 66. This option code (when set) supplies a TFTP boot server address to the DHCP client to boot from.

DHCP must be enabled if using DHCP Option 66/160/150, in order for Provisioning to work.

One of two files can be uploaded on the Provisioning Server (for access via TFTP, FTP, HTTP, or HTTPS):

Generic (for all 8036 SIP Multimedia Intercoms)	algot8036.conf
Specific (for a specific MAC address)	algot[MAC].conf

Both protocol and path is supported for Option 66, allowing for <http://myserver.com/config-path> to be used.

MD5 Checksum

In addition to the .conf file, an .md5 checksum file must also be uploaded to the Provisioning server. This checksum file is used to verify that the .conf file is transferred correctly without error.

A tool such as can be found at the website address below may be used to generate this file:

<http://www.fourmilab.ch/md5>

The application doesn't need an installation. To use the tool, simply unzip and run the application (md5) from a command prompt. The proper .md5 file will be generated in the same directory.

If using the above tool, be sure to use the "-l" parameter to generate lower case letters.

Generating a generic configuration file

1. Connect 8036 to the network
2. Access the 8036 Web Interface Control Panel
3. Configure the 8036 with desired options
4. Click on the System tab and then Maintenance.
5. Click "Download" to download the current configuration file
6. Save the file settings.txt
7. Rename file settings.txt to algot8036.conf
8. File algot8036.conf can now be uploaded onto the Provisioning server

If using a generic configuration file, extensions and credentials have to be entered manually once the 8036 SIP Multimedia Intercom has automatically downloaded the configuration file.

Generating a specific configuration file

Follow steps 1 to 6 as listed in the section "Generating a generic configuration file".

1. Rename file settings.txt to algom[MAC address].conf (e.g. algom0022EE020009.conf)
2. File algom[MAC address].conf can now be uploaded on the Provisioning server.

The specific configuration file will only be downloaded by the 8036 SIP Multimedia Intercom with the MAC address specified in the configuration file name. Since all the necessary settings can be included in this file, the 8036 will be ready to work immediately after the configuration file is downloaded. The MAC address of each 8036 SIP Multimedia Intercom can be found on the back label of the unit.

For more Algo SIP endpoint provisioning information, see:

www.algosolutions.com/provision

Advanced Settings Tab – Tones

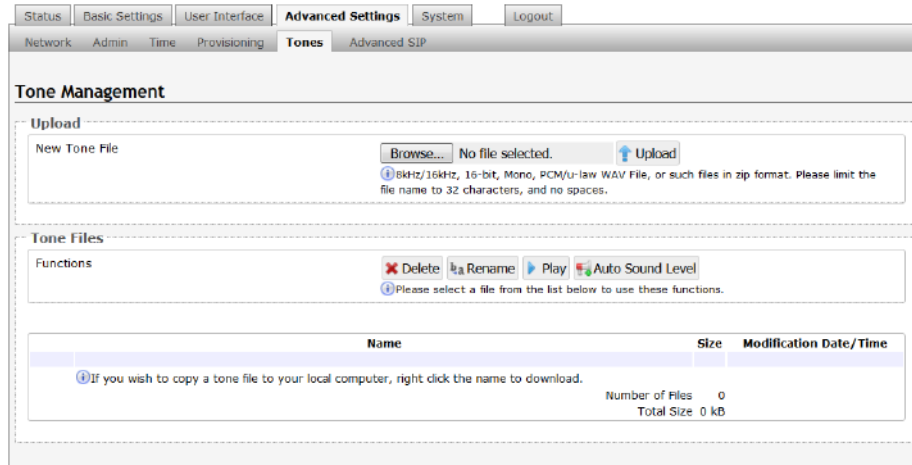

Uploading Custom Audio Files

Custom audio files (WAV format) may be uploaded into memory (1 GB) to play for notification applications.

An existing file may also be modified by downloading the original via the links in the web interface, making the desired changes, and then uploading the new version with a different name. Audio files must be in the following format:

- WAV format
- 8kHz or 16kHz sampling rate
- 16-bit PCM, or u-law
- Mono

A zip files containing one or more audio files may also be uploaded. File names must be limited to 32 characters, with no spaces.

Advanced Settings Tab – Advanced SIP

The screenshot shows the 'Advanced SIP Settings' configuration page. At the top, there are navigation tabs: Status, Basic Settings, User Interface, **Advanced Settings**, System, and Logout. Below these are sub-tabs: Network, Admin, Time, Provisioning, Tones, and **Advanced SIP**. The main content area is titled 'Advanced SIP Settings' and is divided into two sections: 'SIP' and 'Server Redundancy'. The 'SIP' section includes fields for Outbound Proxy, STUN Server, Register Period (seconds) (set to 3600), Keep-alive Method (radio buttons for None and Double CRLF, with Double CRLF selected), and Keep-alive Period (seconds) (set to 30). The 'Server Redundancy' section includes a 'Server Redundancy Feature (Multiple SIP Server Support)' (radio buttons for Enabled and Disabled, with Enabled selected), Backup Server #1 and #2 fields, a Polling Interval (seconds) dropdown menu (set to 120 seconds (2 minutes)), a 'Poll Active Server' section (radio buttons for Enabled and Disabled, with Disabled selected), an 'Automatic Failback' section (radio buttons for Enabled and Disabled, with Enabled selected), and a 'Polling Method' section (radio buttons for SIP NOTIFY and SIP OPTIONS, with SIP NOTIFY selected). A 'Save' button is located at the bottom right of the form.

Outbound Proxy

IP address for outbound proxy. A proxy (server) stands between a private network and the internet.

STUN Server

IP address for STUN server if present.

Register Period (seconds)

Maximum requested period of time where the 8036 SIP Multimedia Intercom will re-register with the SIP server. Default setting is 3600 seconds (1 hour). Only change if instructed otherwise.

Keep-alive Method

If Double CRLF is selected the 8036 SIP Multimedia Intercom will send a packet every 30 seconds (unless changed) to maintain connection with the SIP Server if behind NAT.

Server Redundancy Feature

Two secondary SIP servers may be configured. The 8036 SIP Multimedia Intercom will attempt to register with the primary server but switch to a secondary server when necessary. The configuration allows re-registration to the primary server upon availability or to stay with a server until unresponsive.

If Server Redundancy is selected the web page will expand as shown below.

Backup Server #1

If primary server is unreachable the 8036 SIP Multimedia Intercom will attempt to register with the backup servers. If enabled, the 8036 SIP Multimedia Intercom will always attempt to register with the highest priority server.

Backup Server #2

If backup server #1 is unreachable the 8036 SIP Multimedia Intercom will attempt to register with the 2nd backup server. If enabled, the 8036 SIP Multimedia Intercom will always attempt to register with the highest priority server.

Polling Intervals (seconds)

Time period between sending monitoring packets to each server. Non-active servers are always polled, and active server may optionally be polled (see below).

Poll Active Server

Explicitly poll current server to monitor availability. May also be handled automatically by other regular events, so can be disabled to reduce network traffic.

Automatic Failback

Reconnect with higher priority server once available, even if backup connection is still fine.

Polling Method

SIP message used to poll servers to monitor availability.

System Tab - Maintenance

The screenshot shows the 'System Maintenance' web interface. It features a top navigation bar with tabs: Status, Basic Settings, User Interface, Advanced Settings, System (selected), and Logout. Below this is a sub-navigation bar with tabs: Maintenance (selected), System Log, Credits, and About. The main content area is titled 'System Maintenance' and is divided into four sections:

- Backup / Restore Configuration**
 - Download Configuration File: Download
 - Restore Configuration File: Browse... No file selected. Restore
 - Restore Configuration to Defaults: Restore Defaults
- Backup / Restore User Interface Files**
 - Backup in zip format includes UI configuration file and all uploaded files, images, sounds, etc.
 - Download UI Backup Zip File: Download
 - Restore from UI Backup Zip File: Browse... No file selected. Restore
 - Restore All UI Settings and Files to Defaults: Restore Defaults
- Reboot**
 - Reboot the device: Reboot
- Upgrade to New Firmware**
 - Method: From Local Files From URL
 - Firmware Image: Browse... No file selected.
 - MD5 Checksum: Browse... No file selected.
 - Upgrade

Download Configuration File

Save the device settings to a text file for backup or to setup a provisioning configuration file.

Restore Configuration File

Restore settings from a backup file.

Restore Configuration to Defaults

Resets all 8036 SIP Multimedia Intercom device settings to factory default values. *This will not restore the UI to defaults.*

Download UI Backup SIP File

Save the device UI settings to a ZIP file for backup.

Restore from UI Backup ZIP File

Restore UI settings from a backup ZIP file.

Restore All UI Settings and File to Defaults

Resets all 8036 SIP Multimedia Intercom device settings to factory default values. *This will not restore the general device settings to defaults.*

Reboot the Device

Reboots the device.

Method

Specify whether the firmware files will be downloaded from the local computer or a remote URL.

Firmware Image

Point to the firmware image provided by Algo

MD5 Checksum

Point to the checksum file provided by Algo

Upgrade 8036 SIP Multimedia Intercom Firmware

1. From the top menu, click on System, then Maintenance.
2. In the Upgrade section, click on Choose File and select the 8036 SIP Multimedia Intercom firmware file to upload. Note that both the FW firmware and MD5 checksum files must be loaded.
3. Click Upgrade
4. After the upgrade is complete, confirm that the firmware version has changed (refer to top right of Control Panel).

System – System Log

System log files are automatically created and assist with troubleshooting in the event the 8036 SIP Multimedia Intercom does not behave as expected.

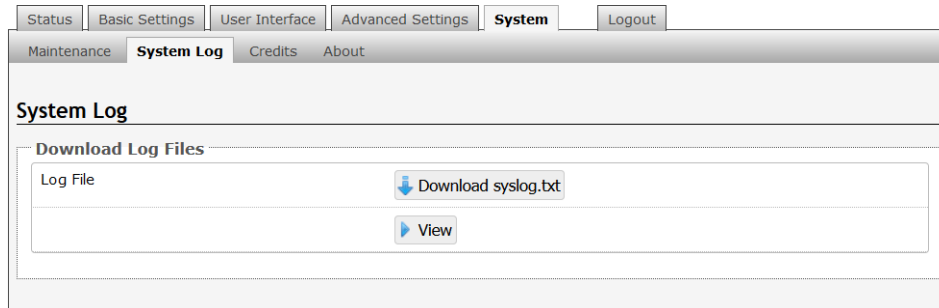

Specifications

SIP Compliance:	RFC3261
Power Input:	48 V PoE Class 0 (Max 12.95 W - Idle 3 W)
Physical Connection:	RJ45
LCD Display:	Active TFT 5.7" (14.5cm) color VGA, 80° viewing, sunlight readable, 1000:1 contrast, and 800 cd/m2 backlight
Codecs Supported:	G.711, G.722 audio H.264 video (CIF resolution), JPEG still image
Camera:	1/3" (8.5mm) wide VGA CMOS Digital Image Sensor; 6.0 x 6.0µm pixel size for low light performance; 110dB dynamic range
Image Memory:	Optional to 8 GBytes
Touchscreen:	Optically bonded projected capacitance, H7 hardness
Presence Detection:	Area reflective 80cm range, invisible light beam
Speaker:	Wideband 8 W
Microphones:	Dual beam forming, wideband
Hands-free:	Full-duplex capable, reverting to hands-free half duplex employing DSP echo cancellation and noise reduction for reliable communication in difficult outdoor environments
Programmability:	Web interface option configuration.
Environmental:	IP64 weather resistant; Ambient temperature: -30 to +60° C (-22 to 140° F)
Compliance:	FCC, CSA/UL, CE
Door/Gate Control:	Separate controller SIP end point for physical security, sensing inputs, and third party equipment interfaces

Dimensions:

Height: 10-3/4" (27.3 cm)

Width: 7" (17.8 cm)

Depth: 3" (7.6 cm)

8061 IP Relay Controller

The 8036 can provide door control functionality when used with the optional Algo 8061 IP Relay Controller.

The 8061 serves as a bridge between the 8036 and peripheral hardware such as door strike.

As a door opening controller, the 8061 can be located in a secure environment to prevent tampering of the public-facing intercom.

The door control feature is activated by a command from the answering telephone keypad, or entry of the door release code by a visitor via the 8036 itself.

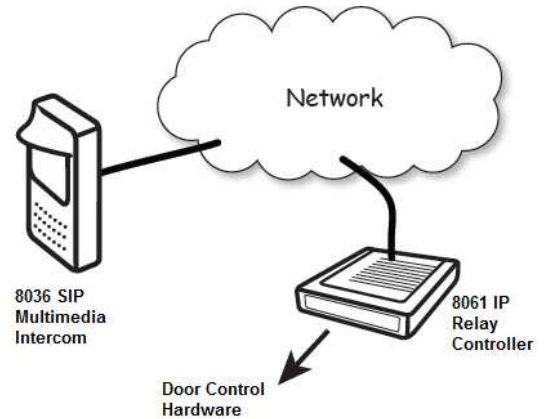

Typical 8036/8061 Setup

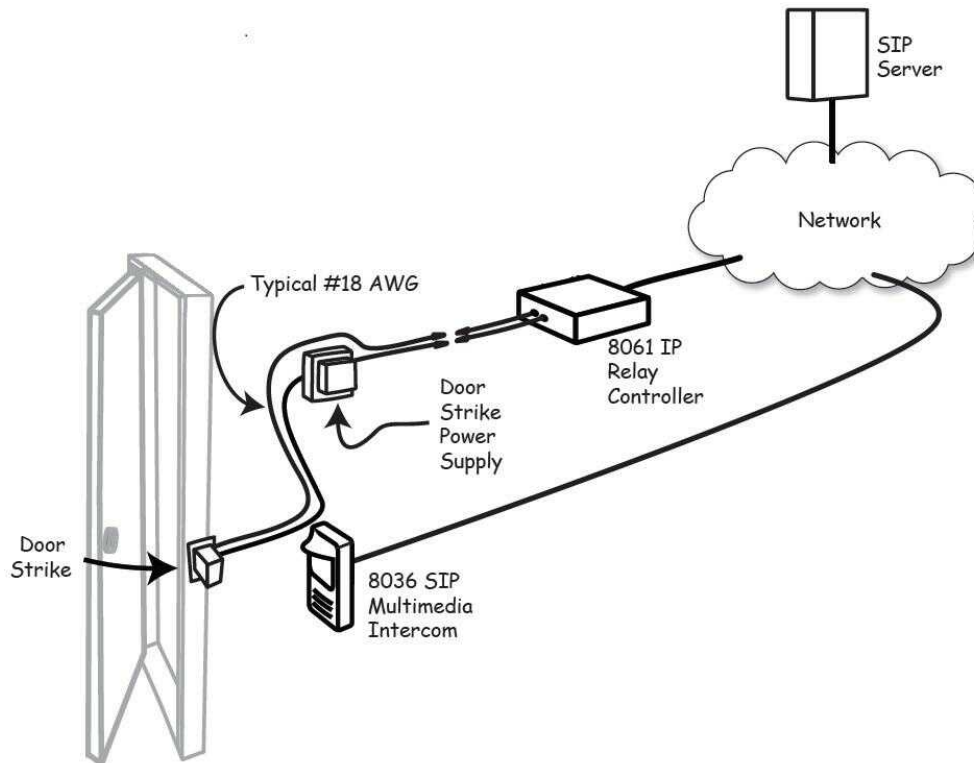

PoE and Relay Connections on back of 8061 IP Relay Controller:

1. Connect the 8061 to the network via an Ethernet cable at the back of the device. Ensure that a PoE port is used for power and that the 8061 is connected to the same subnet and VLAN as the target intercom.
2. Run two wires from the door strike to the Normally Open/Common (NO/C) input pair or Common/Normally Closer (C/NC) input pair on the 8061. For more wiring information please visit: www.algosolutions.com/doorstrike.

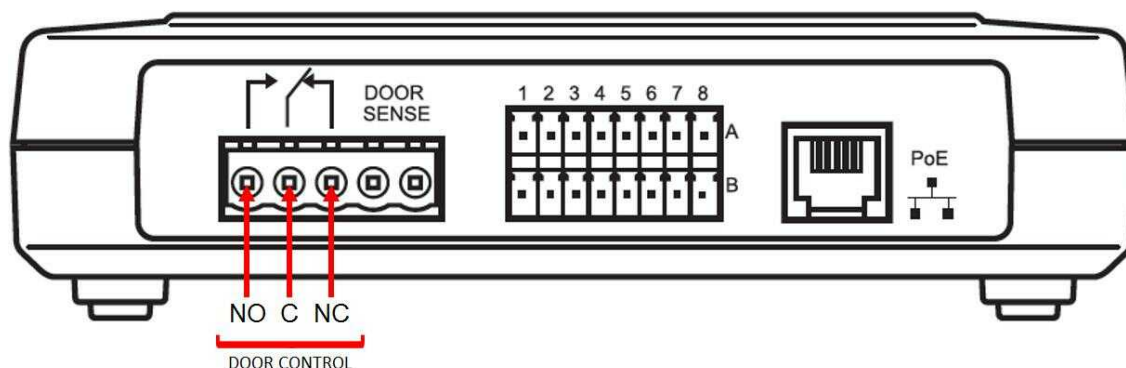

Configuring the 8061

1. Find the IP address of the Algo 8061 using the Algo locator tool available from the Algo website www.algosolutions.com/locator. This tool displays all of the Algo devices available on the network, and their corresponding IP addresses. Note this address down as you will need it when you configure the 8036 for use with this device.
2. Point your browser to the above IP address. The 8061 Control Panel will be displayed.
3. Log in. The default password is **algo**.
4. Go to the **Basic Settings > Door Control** tab.



The screenshot shows a web interface with a navigation menu at the top containing 'Status', 'Basic Settings', 'Advanced Settings', 'System', and 'Logout'. Below this is a sub-menu with 'SIP', 'Input', 'Events', and 'Door Control'. The 'Door Control' sub-menu is active, and the page title is 'Door Relay Settings'. The main content area is titled 'Door Relay' and contains two fields: 'Door Control Link' with radio buttons for 'Enabled' (selected) and 'Disabled', and 'Door Control Password' with a text input field containing '1234' and a blue eye icon. A 'Save' button with a green checkmark is located at the bottom right of the form.



5. Set the "Door Control Link" to "Enabled".
6. In the "Door Control Password" field set a password that will be used for configuring the intercom for door control. Note this password down as you will be reusing it when configuring the 8036 with this device.

See section "Basic Settings Tab – Door Control" page [33](#) for configuring the 8201 with the parameters from above.

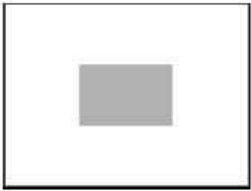
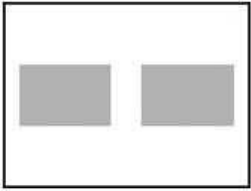
Button Positioning Table

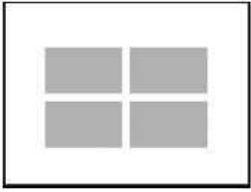
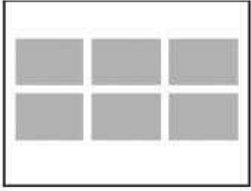
The following table provides the location and sizing of standard button layouts for 8036 User Interface Screens.

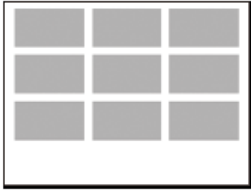
Button Layout		Button Dimensions (in pixels) Width x Height	Upper Left X, Y Button Position(s) (in pixels)
Single Button		240 x 160	200,160
2 Buttons		240 x 160	40, 160 360,160
3 Buttons		180 x 120	30,160 230,160 430,160
2 x 2 Buttons		200 x 120	110,120 330,120 110,260 330,260
3 x 2 Buttons		180 x 120	30,100 230,100 430,100 30,240 230,240 430,240

<p>3 x 3 Buttons</p>		<p>180 x 100</p>	<p>30,20 230,20 430,20 30,140 230,140 430,140 30,260 230,260 430,260</p>
<p> The 3 x 3 Buttons layout is similar to 3x3 Full Screen layout below but has extra space at bottom to allow the unobstructed use of the Home and Back buttons.</p>			
<p>3 x 3 Buttons Full Screen</p>		<p>180 x 100</p>	<p>30,80 230,80 430,80 30,200 230,200 430,200 30,320 230,320 430,320</p>

Adobe® Photoshop® Templates

To simplify the process of creating graphic screens with buttons that exactly line up to pre-configured 8036 button layouts, Photoshop templates are available at: www.algosolutions.com/8036templates

Here you'll find a link to a ZIP file containing multiple Photoshop files that provide guides for laying out User Interface screens for the 8036. Each file contains guides for placing buttons that corresponds to the 8036's standard button configurations.

To use the files, open up the Photoshop file that corresponds to the button configuration you want to use. Then set Photoshop to snap to guides (**View>Snap To>Guides**). Then use Photoshop's Rectangle Tool to draw buttons using the guides. After completing the button graphics, choose the File>Save for Web and Devices menu and use the PNG-24 preset to create the PNG file for importing into the 8036.

FCC Compliance Statement

This equipment has been tested and found to comply with the limits for a Class A digital device, pursuant to Part 15 of the FCC Rules. These limits are designed to provide reasonable protection against harmful interference when the equipment is operated in a commercial environment. This equipment generates, uses, and can radiate radio frequency energy, and if it is not installed and used in accordance with the instruction manual, it may cause harmful interference to radio communications. Operation of this equipment in a residential area is likely to cause harmful interference, in which case the user will be required to correct the interference at his own expense.