



# **Zone Controller with Universal Telephone Interface UTI312 Model**

Installation and Use Manual

## Notice

Every effort was made to ensure that the information in this manual was complete and accurate at the time of printing. However, information is subject to change.

### FCC Statement (Part 15) - Radio Frequency Interference

The Universal Telephone Interface generates and uses radio frequency energy and if not installed and used in strict accordance with the manufacturer's instructions, may cause interference to radio and television reception. Testing is being conducted for compliance with the limits for a Class B device in accordance with the specifications in Part 15 of the FCC Rules and Canadian D.O.C. regulations. This testing is designed to provide reasonable protection against such interference. However, there is no guarantee that interference will not occur in a particular installation. If this equipment does cause interference to radio or television reception, which can be determined by turning the UTI312 unit off and on, the user is encouraged to try to correct the interference by one or more of the following measures:

- Reorient the radio or TV receiving antenna.
- Relocate the UTI312 unit with respect to the radio or TV receiver or vice-versa.
- Plug the UTI312 unit into a different outlet so that it and the radio or TV receiver are on different branch circuits.

If necessary, the user should consult the dealer or an experienced radio/television technician for additional suggestions. The user may find the following booklet, "How To Identify and Resolve Radio-TV Interference Problems," helpful. This booklet was prepared by the Federal Communications Commission (FCC) and is available from the U.S. Government Printing Office, Washington, DC 20402. Stock order No. 004-000-00345-4.

### Federal Communications Commission (FCC) Statement (Part 68)

This equipment is component registered with the Federal Communications Commission (FCC) in accordance with Part 68 of its rules. In compliance with the rules, be advised of the following:

Registered equipment may not be used with Coin Telephone Lines. Equipment may be used with Party Lines in areas where state tariffs permit such connections and when equipment is adaptable for such service.

This equipment is registered as follows:  
Registration Number - CD2PA13BUTI312  
Ringer Equivalence - 1.4B

If trouble is experienced, the equipment should be disconnected from the interface to determine if this equipment, or the telephone line is the trouble source. If the equipment is determined to be malfunctioning, it should not be reconnected until repairs are effected.

Repairs to this equipment, other than routine repairs, can be made only by the manufacturer or its authorized agents.

If the equipment causes harm to the telephone network, the local telephone company may temporarily discontinue your service and, if possible, notify you in advance. If advance notice is not practical, you will be notified as soon as possible. You will be given the opportunity to correct the problem and informed of your right to file a complaint with the FCC.

The local telephone company may make changes in its facilities, operations, or procedures that could affect the proper functioning of your equipment. If they do, you will be given adequate notice in writing to allow you an opportunity to maintain uninterrupted telephone service.

## Important Safety Information

Always follow these basic safety precautions when installing and using the system:

1. Read and understand all instructions.
2. Follow all warnings and instructions marked on the product.
3. DO NOT block or cover the ventilation slots and openings. They prevent the product from overheating. DO NOT place the product in a separate enclosure or cabinet, unless proper ventilation is provided.
4. Never spill liquid on the product or drop objects into the ventilation slots and openings. Doing so may result in serious damage to the components.
5. Repair or service must be performed by a factory authorized repair facility.
6. The product is provided with a UL-CSA approved, 3-wire ground type plug. This is a safety feature. DO NOT defeat the safety purpose of the grounding type plug. DO NOT staple or otherwise attach the AC power supply cord to building surfaces.
7. DO NOT use the product near water or in a wet or damp place (such as a wet basement).
8. DO NOT use extension cords. The product must be installed within 6 feet of a grounded outlet receptacle.
9. DO NOT install telephone wiring during a lightning storm.
10. DO NOT install telephone jacks in a wet location unless the jack is specifically designed for wet locations.
11. Never touch uninsulated wires or terminals, unless the line has been disconnected at the paging or controller interface.
12. Use caution when installing or modifying paging or control lines.

# Contents

<b>Introduction .....</b>	<b>4</b>	<b>Features &amp; Operation .....</b>	<b>14-17</b>
Voice Channel .....	4	Zones .....	14
Background Music .....	4	Paging Zone Groups.....	14
Signaling Tones .....	4	All-Call Zone Group .....	14
Other Features .....	4	Auto Select Zone Group .....	15
Package Contents .....	4	Override Zone Group & Tone.....	15
<b>Panel Descriptions.....</b>	<b>5</b>	Night Ring Zone Group & Tone .....	15
<b>Installation .....</b>	<b>6-7</b>	Tone Trigger 1 & 2 Zone Groups & Tones .....	15
Mounting .....	6	Code Call Zone Group & Tones.....	16
ZX3 Module Installation & Jumper Selections.....	7	AUX Relay Contact .....	16
<b>Telephone Interface</b>		Flexible Dialing.....	16
<b>Wiring Connections &amp; Setup.....</b>	<b>7-10</b>	Confirmation Tone .....	16
Telephone System Connections .....	7	Pre-Announce Tone .....	16
PBX Analog Station Port .....	7	Dialing Time-out .....	17
PBX Loop Start Trunk Port .....	8	DTMF Block .....	17
PBX Ground Start Trunk Port .....	8	Trunk Disconnect .....	17
Trunk Disconnect .....	9	Timers .....	17
PBX Page Port Contact.....	9	Calling Party Controlled Disconnect .....	17
PBX Page Port VOX .....	9	Setup Tone.....	17
Override Input.....	10	Reset Default Values .....	17
90V Night Ring Input .....	10	Priority Levels .....	17
<b>Other Connections .....</b>	<b>11</b>	<b>System Programming .....</b>	<b>18-22</b>
Night Ringer Contact.....	11	Paging Zone Groups .....	18
Tone Trigger Inputs 1 & 2 .....	11	All-Call Zone Group .....	18
Background Music Inputs .....	11	Auto Select Zone Group .....	18
UT1312 AUX Contacts .....	11	Tone Zone Groups .....	19
<b>ZX3 Module Connections.....</b>	<b>12</b>	Code Calling.....	19
ZX3 Module Paging Output Connections .....	12	DTMF Block .....	19
ZX3 AUX Contacts .....	12	Timers .....	19
ZX3 Power Supply Output.....	12	AUX Relay Contact .....	20-21
<b>Controls .....</b>	<b>13</b>	Flexible Dialing.....	22
Paging Level.....	13	Flexible Dialing Reference Chart.....	22
Music Level .....	13	<b>Feature Codes &amp; Defaults .....</b>	<b>23-26</b>
Tone Level.....	13	<b>Specifications .....</b>	<b>27</b>
Night Ring Level .....	13	<b>Block Diagram, UT1312 .....</b>	<b>28</b>
Limiter Threshold .....	13	<b>Block Diagram, ZX3 .....</b>	<b>29</b>
		<b>Limited Warranty .....</b>	<b>30</b>

# Introduction

---

The UTI312 Paging System is an expandable multi-zone paging and signaling system. The system provides the following features and functions:

## Voice Channel

- Expandable to 12 zones
- Telephone interfaces:
  - loop start trunk
  - ground start trunk
  - station access (analog ring-up)
  - page port contact closure activation
  - page port voice activation
- Override paging (using loop start trunk or page port contact closure activation) zone group
- Audio output with level control per zone can provide audio for 150 Bogen one-way self-amplified speakers; also compatible with 70V amp inputs
- Zone activity LEDs
- Zone contact closure
- Pre-Announce/Confirmation Tone
- Adjustable Automatic Level Control with threshold and active indicator

## Background Music

- Two high-impedance transformer isolated BGM inputs
- Individual volume controls
- Background music source selectable per zone
- Stereo combining inputs

## Signaling Tones

- Night Ringer (90V and contact closure activation) with zone group
- Two Tone Triggers (tone and duration selectable, closure activated) with individual zone groups
- Code Calling with zone group

## Other Features

- Flexible dialing plan for zone numbers
- 2 to 5 digit dialing plans
- 24 zone groups
- C-form contact set with programmable activation events
- Non-volatile memory for setup data
- Setup Tone to assist in volume setting, etc.
- Pluggable terminal strips
- Microcontroller-based operation
- DTMF setting of operating parameters

## Package Contents

- (1) UTI312
- (1) Installation and Use Manual
- (1) ZX3 Module (installed)
- (2) Brackets

# Panel Descriptions

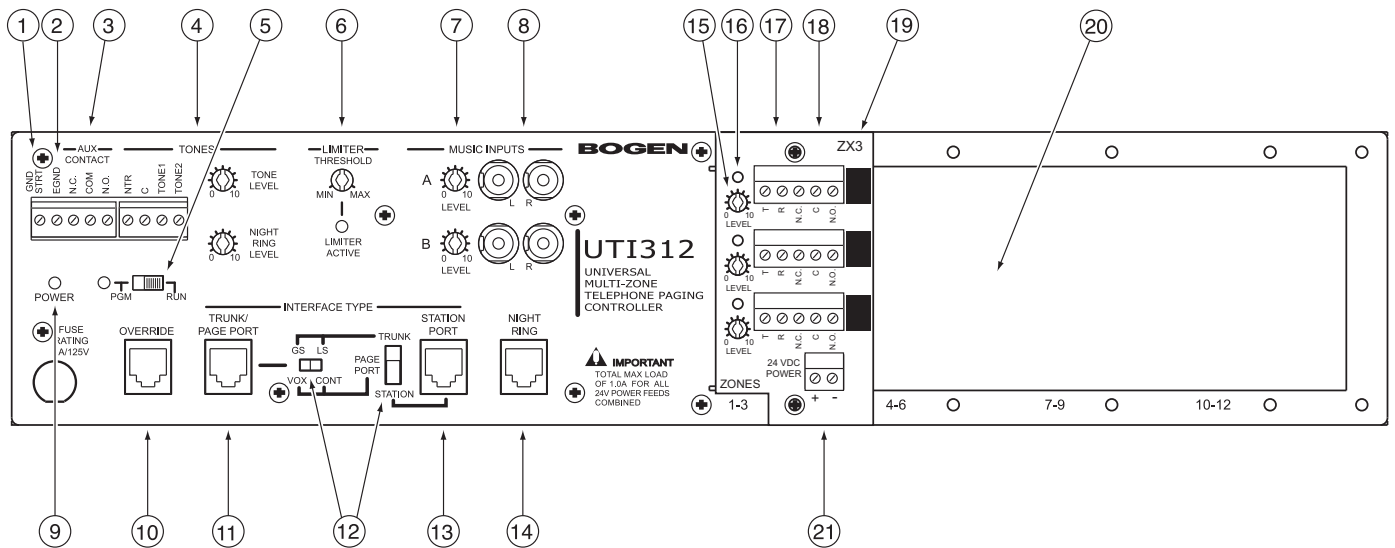

## UTI312 Callouts

1. **Ground Start Terminal** - Connection for PBX ground. Used only when the ground start interface is selected.
2. **Earth Ground Terminal** - Provides connection to the UTI312 Earth Ground. This terminal can be connected to the GND STRT terminal when using the ground start interface if the UTI312 and the PBX share the same Earth Ground.
3. **AUX Contact Terminals** - Provides connections for normally open and normally closed contact closures. The contact closure can be programmed to activate during paging, night ring, tone, override, or any combination (refer to *System Programming*).
4. **Tone and Night Ring Terminals / Tone and Night Ring Level Controls** - Terminals provide connections to night ring and tone trigger inputs. Tone Level control sets the level of all tones produced by the system except for the Night Ring tone. Night Ring Level control sets level of Night Ring tone.
5. **Program/Run Switch & LED** - Switch to set unit to Program mode. The LED will light when unit is in Program mode.
6. **Limiters Threshold / Limiter Active LED** - Threshold control and indicator for output limiter function.
7. **Music Level Control** - Music Level control sets the background music level for music sources A and B.
8. **Music Input Jacks** - Stereo summing input for background music sources A and B.
9. **Power Indicator** - Illuminates when AC power has been applied to the unit.
10. **Override** - Highest priority input allows for loop start or page port with contact activation or open collector output.
11. **Trunk/Page Port** - Primary paging interface to telephone system when UTI312 is set to trunk or page port mode type interface.
12. **Interface Type Slide Switches** - Sets telephone interface type for the UTI312.
13. **Station Port** - Primary paging interface to telephone switch when UTI312 is set to station mode type interface.
14. **Night Ring** - Provides LS connection for 90V Night Ring.

## ZX3 Callouts

15. **ZX3 Module Zone Page Level Controls** - Level controls adjust the level of the page output for each zone. Each zone has its own Level control.
16. **ZX3 Module Zone Active LED** - The LED for each zone will light when the zone is active.
17. **ZX3 Module Zone Page Terminals** - Provides audio signal for up to 150 self-amplified speakers.
18. **ZX3 Module Zone Contact Terminals** - N.O./N.C. contacts change state when zone is active.
19. **ZX3 Plug-In Module** - Provides 1 to 3 paging zones; add up to 3 additional ZX3 modules for up to 12 paging zones.
20. **Module Bay** - Module bay accepts up to four ZX3 modules, for a total of 12 zones of paging. One pre-installed.
21. **Auxiliary 24V Terminals** - Provides connections to the UTI312 1A, 24V DC power supply for powering self-amplified speakers.

# Installation

---

## Mounting

### Wall Mounting

Mounting to a plywood backboard or studs:

1. On each side remove the four screws in the corners and use them to attach the mounting flanges so that the flanges are facing the rear of the unit.
2. Hold the unit level against the surface to which it will be mounted.
3. Using the keyholes, mark on the mounting surface where the mounting screws (not included) should be positioned.
4. Set the unit aside and install the screws leaving about  $\frac{1}{4}$ " of the screws sticking out of the surface.
5. Slip the unit over the screws through the keyholes and let the unit rest on the screws. Tighten screws snugly.

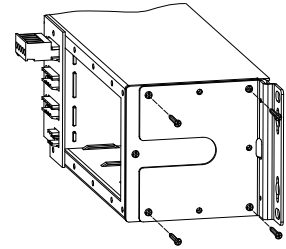

Wall Mounting

### Rack Mounting, Flush

Mounting flush to a rack:

1. On each side remove the four screws in the corners and use them to attach the mounting flanges so that the flanges are facing the front of the unit.
2. Attach unit to rack with 4 rack screws (not supplied). Do not use keyholes for mounting to a rack.

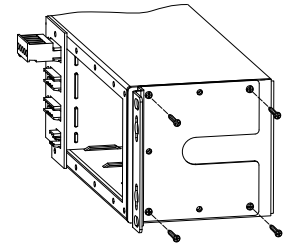

Rack Mounting, Flush

### Rack Mounting, Recessed for Wire Access

Recessed in a rack to allow for top or bottom wire entry:

1. On each side remove the four screws in the corners and use them to mount the mounting flanges so that the flanges are protruded from the front of the unit. This recess allows enough space for wire access from top or bottom.
2. Attach unit to rack with 4 rack screws (not supplied). Do not use keyholes for mounting to a rack.

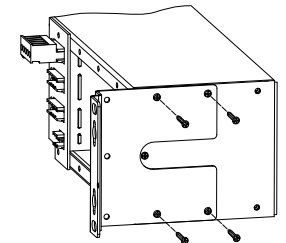

Rack Mounting, Wire Access

### Rack Mounting Considerations

If installed in a closed or multi-unit rack assembly, the operating ambient temperature of the rack environment may be greater than room ambient. Therefore, consideration should be given to installing the equipment in an environment compatible with the manufacturer's maximum rated ambient temperature (T<sub>mra</sub>). Maximum recommended ambient temperature for the UTI312 is 40° C and 104° F.

Installation of the equipment in a rack should be such that the amount of air flow required for safe operation of the equipment is not compromised.

Circuit overloading consideration should be given to the connection of the equipment to the supply circuit and the effect that overloading of circuits might have on overcurrent protection and supply wiring. Appropriate consideration of equipment nameplate ratings should be used when addressing this concern.

Reliable earthing of rack-mounted equipment should be maintained. Particular attention should be given to supply connections other than direct connections to the branch circuit (e.g., use of power strips).

## ZX3 Module Installation & Jumper Selections

The UTI312 module bay can accommodate up to four ZX3 modules. Each ZX3 module has 3 zone outputs giving the UTI312 a capacity of up to 12 paging zones.

Each module slot is marked on the lower left hand corner indicating which zones correspond with each slot (see figure below).

To install, first select each zone's Music Bus A or B or (no music) using the jumpers, then slide the ZX3 module into the card guides and push the module all the way in. Secure with mounting screws.

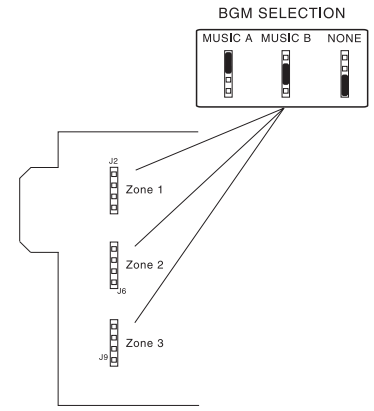
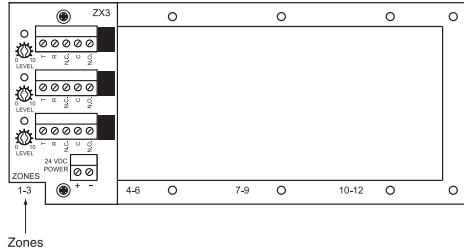

ZX3 BGM Jumper Selections

# Telephone Interface Wiring Connections & Setup

## Telephone System Connections

The UTI312 connects to virtually any telephone system: PBX station lines and CO lines, PBX loop start trunk ports, PBX ground start trunk ports, and page ports.

Interface installation consists of setting the slide switches and connecting with modular (RJ11) telephone plugs. Refer to the appropriate procedure in this section to connect the UTI312 to the telephone system.

*Note: In all cases, make sure that power to the UTI312 is disconnected before performing the installation.*

## PBX Analog Station Port

In this configuration, the unit answers immediately upon detecting a ring. As soon as it answers, the default timer and VOX timer are started. The default timer determines the maximum length of any page. The VOX timer repeatedly resets as long as audio is detected on the line. If no audio is detected within the VOX time period, then the page will end. If audio continues to be detected, then the default timer will control page length.

The unit will also immediately disconnect if a loss of loop current CPC (Calling Party Disconnect) is detected.

Make sure that the power is off and all connections are completed before proceeding. Move the interface slide switch on the UTI312 to STATION. The other interface slide switch is not used and can be in any position. Use a modular telephone cord (minimum 2-conductor) to connect the UTI312 Station Port RJ11 to the phone system. The center two conductors are Tip and Ring and are not polarity sensitive (see below). Set Default and VOX timers (see *System Programming*). The timers can be independently inhibited.

*Note: The default time-out is factory set to 30 seconds, and the VOX time-out is set to 6 seconds. If both the default and VOX timers are inhibited, the only way to release the system from the station line is through the use of a Calling Party Control (CPC) pulse.*

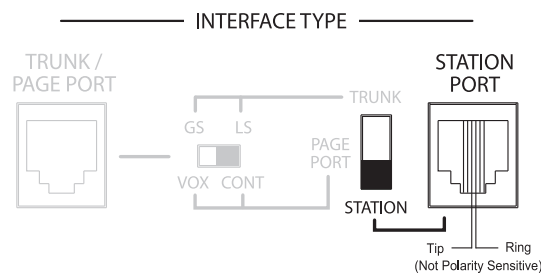

## PBX Loop Start Trunk Port

In this configuration, the unit supplies a 24V talk battery and loop current detection. When the unit detects a loop resistance between Tip and Ring, it activates. When the loop opens, the page ends. The unit follows the status of the trunk port.

Before configuring the UTI312 for a loop start trunk port, make sure that the power is disconnected and all other connections are completed. Move the slide switches on the UTI312 to the positions shown below. Use a modular telephone cord to connect the unit to the phone system.

The center two conductors are Tip and Ring (24V DC) and have a specific polarity as shown in the figure below. If the polarity that the trunk requires is opposite, you can use a reversing modular cord to make the connection or reverse the connection through a modular block. The Trunk Disconnect feature is available in this mode (*description on page 9*).

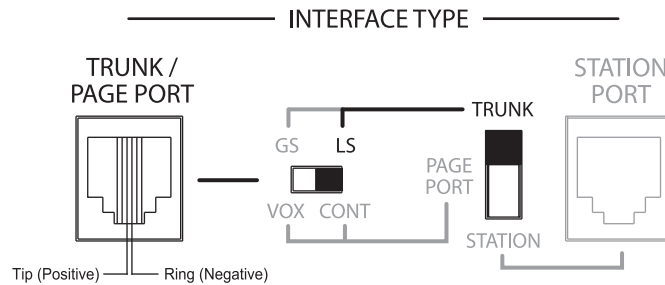

## PBX Ground Start Trunk Port

In this configuration, the unit supplies 24V talk battery, a contact in the Tip circuit, and loop current detector in the ring circuit. When the ground start trunk grounds Ring, the unit responds by closing the connection to Tip, which completes the access procedure. When the loop is opened, the page ends. The unit follows the status of the trunk.

Before proceeding, make sure that the power is disconnected and all other connections are completed. Move the slide switches on the UTI312 to the positions shown below. Use a modular telephone cord to connect the unit to the phone system. Connect the GND STRT terminal on the UTI312 to the PBX ground. This is typically the AC ground for the PBX system. If the PBX is using the same Earth Ground as the UTI312, the Earth Ground terminal can be shorted to the GND STRT terminal instead of running a ground wire from the PBX.

The center two conductors are Tip and Ring (24V DC) and have a specific polarity as shown in the figure below. If the polarity that the trunk requires is opposite, you can use a reversing modular cord to make the connection or reverse the connection through a modular block. The Trunk Disconnect feature is available in this mode (*description on page 9*).

**IMPORTANT** - When the GND STRT terminal is connected to Earth Ground, it is important that none of the UTI312 system ground terminals are connected to Earth Ground. These terminals may accidentally be connected to Earth Ground when external equipment, such as a CD player, tuner, announcement device, etc., is connected to the UTI312. The UTI312 ground points are: the closure return terminal for the Trunk/Page Port jack, the contact closure (GND) and the left-most Dry Audio input terminal of the Override jack, the C terminal for the Night Ring, and the Tone Trigger input. The background music input and page outputs are transformer-isolated and are unaffected by Earth Ground. If the UTI312 system ground is tied to Earth Ground, then the UTI312 talk battery voltage will be shorted to ground and the unit will not function properly. For location of UTI312 system ground terminals, refer to the *UTI312 Block Diagram*.

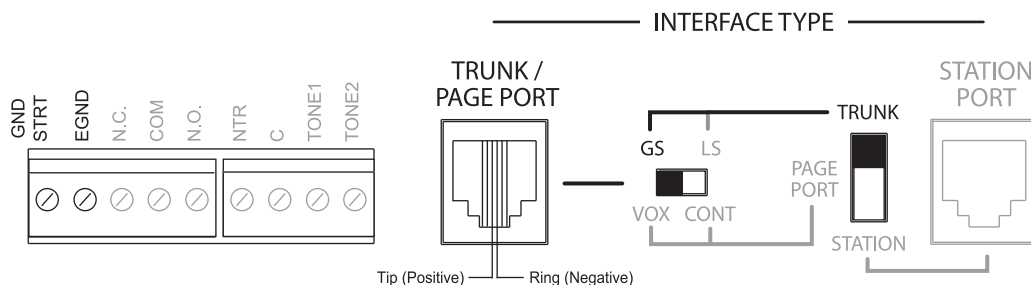



## Trunk Disconnect

The UTI312 includes a Trunk Disconnect feature. The purpose of the Trunk Disconnect feature is to release the UTI312 from the trunk port in the event a user does not hang up the phone properly after making a page. If the UTI312 does not detect voice for the interface VOX time-out period, or if the interface default timer expires, the UTI312 will attempt to release from the trunk. When using the Trunk Disconnect feature, the PBX must have disconnect supervision available on the trunk port being used. The Trunk Disconnect feature is disabled by default. To set the VOX and default timers and enable the feature, refer to *System Programming*.

## PBX Page Port Contact

In this configuration, the unit responds to a contact shorting the closure source to its return. When the short is removed, the page ends. Audio is provided to the system through a separate pair of dry audio input leads.

Make sure that the power is disconnected and all other connections are completed before proceeding. Move the slide switches on the UTI312 to the positions shown below. Use a modular telephone cord to connect the module to the phone system.

The center two conductors are used for dry audio (no DC voltage) and the connectors on either side are connected to the page port contact closure. The maximum resistance of the page port contact closure loop resistance is 1000 ohms. Open collector type outputs may also be used for controlling a page. The Trunk Disconnect feature is not available in this mode.

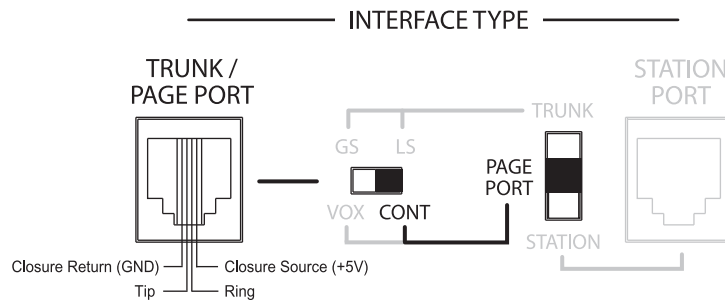

## PBX Page Port VOX

In this configuration, the unit activates when audio on the page input is detected. Loss of audio allows the VOX timer to expire and ends the page.

Make sure that the power is disconnected and all other connections are completed before proceeding. Move the slide switches on the UTI312 to the positions shown below. Use a modular telephone cord to connect the module to the phone system. The center two conductors are used for dry audio and are not polarity sensitive. The Trunk Disconnect feature is not available in this mode.

*Note: The default time-out is factory set to 30 seconds, and the VOX time-out is set to 6 seconds. If both the default and VOX timers are inhibited, there is no way to release the system from the page port VOX.*

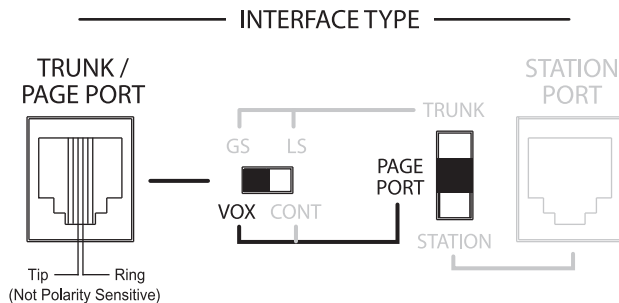

## Override Input

The Override is a feature that lets the caller take priority over all other paging functions and make a page.

The center two conductors interface directly to a Loop Start Trunk or a dedicated phone. When the trunk becomes active, the UTI312 goes into Override mode. A contact closure and dry audio source can also be used for the Override Input. The two conductors flanking the talk battery conductors provide a dry audio gateway into the system override. Override is activated by shorting the outermost conductors.

Maximum contact closure resistance is 1000 ohms. Open collector type outputs for controlling a page may also be used. The Override feature includes a quad beep pre-announce tone that can be enabled or disabled. (The default is enabled.) Make sure that the power is disconnected and all other connections are completed before proceeding. Plug modular cord into OVERRIDE (RJ11) jack.

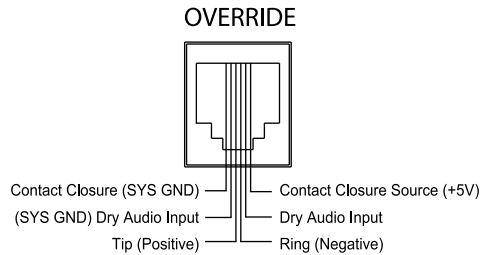

## 90V Night Ring Input

The 90V Night Ring Input connects to an analog station line from the PBX or directly to a central office phone line. The UTI312 will follow the incoming ring signal cadence with a simulated ring or chime tone to the Night Ring zone group.

*Note: The Night Ring feature has priority just above background music. There is a 5-second delay after the night ring stops before background music is restored (to bridge inter-ring pause).*

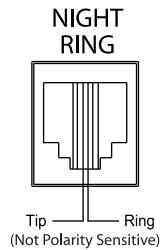

# Other Connections

## Night Ringer Contact

In addition to 90V ring activation of the Night Ring feature, a contact triggered feature is also available.

The night ringer by default sounds a simulated ring tone, but can be programmed to sound a chime tone to the night ring zone group (same as 90V activation).

To connect to the night ring input:

1. Make sure that the power is disconnected.
2. Wire the contact closure used for night ring to the NTR (+5V) and C terminals on the UTI312. Maximum contact resistance for contact closure activation is 1000 ohms. Open collector type outputs for controlling a page may also be used.

*Note: The Night Ring feature has priority just above background music. There is a 5-second delay after the night ring stops before background music is restored (to bridge inter-ring pause).*

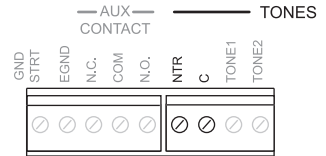

## Tone Trigger Inputs 1 & 2

The UTI312 tone trigger inputs produce a variety of tones for a variety of purposes. Common uses are as a doorbell annunciator or to signal shift changes. Possible tones include slow whoop, steady tone burst, chime, and double chime. Tone 1 has a higher priority than Tone 2. The tone type, as well as the contents of the zone group, are programmable. Refer to *System Programming* section.

To connect to the tone trigger input:

1. Make sure that the power is disconnected.
2. Wire the contact closure used for tone trigger to the TONE1/TONE2 (+5V) and C terminals on the UTI312. Maximum contact resistance for contact closure activation is 1000 ohms. Open collector type outputs for controlling a page may also be used.

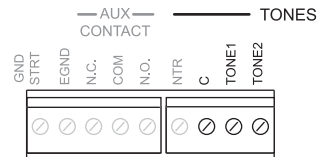

## Background Music Inputs

The UTI312 system provides two high-impedance, transformer-isolated, summed stereo background music inputs with level controls. Mono sources can be connected to either the "L" or "R" jacks.

## UTI312 AUX Contacts

The UTI312 system provides a C-form contact rated at 2A @ 30V DC and 0.6A @ 125V AC, which can be used to activate external equipment. The relay can be programmed to change state when specific events or combination of events (time tone, override, night ring, paging) occur. Refer to the *System Programming* section.

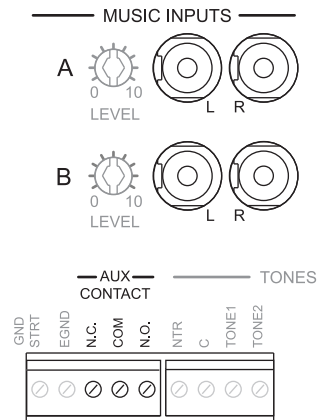

# ZX3 Module Connections

---

## ZX3 Module Paging Output Connections

There are three zone paging outputs on the ZX3 module. The paging outputs are intended to connect to self-amplified speakers, but are also compatible with amplifier inputs as well. The Tip (T) and Ring (R) connections are transformer-isolated audio outputs for driving up to 150 self-amplified speaker inputs.

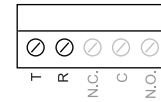

## ZX3 AUX Contacts

Each zone on the ZX3 module has a C-form contact rated at 1A @ 30V DC and 0.5A @ 125V AC. They change state when the corresponding zone becomes active. The ZX3 AUX contacts are not programmable.

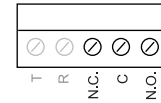

## ZX3 Power Supply Output

A 24V DC, 1A regulated power supply, built into the UTI312, can be used to supply power to self-amplified speakers through a 2-pin plug-in connector on the ZX3 module. The + and - terminals provide 24V DC for powering the self-amplified speakers. The UTI312 can supply a total of 1A @ 24V DC through all of these connectors.

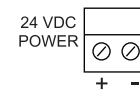

# Controls

---

## Paging Level

The ZX3 module has controls for adjusting the audio level of each zone independently. These serve as master level controls that allow for overall zone control. Setting the initial volume to half is a good starting point. If the speakers have their own level control, then the installer will have to determine the proper setting for each speaker depending on the application. Each level control includes an LED indicator above it to indicate if the zone is active.



## Music Level

The UT1312 has two background music input level controls. Once the page level has been adjusted, set the music level control to the desired background music level.

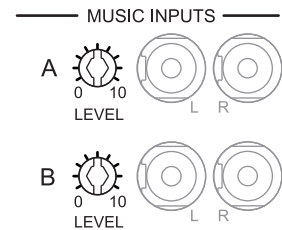

## Tone Level

The Tone Level control sets the level for Tone Trigger 1 and 2, pre-announce tone, confirmation tone, and code call tones.



## Night Ring Level

The Night Ring Level control sets the level for the Night Ring tone.



## Limiter Threshold

Because everyone doesn't speak at the same level, the UT1312 includes a limiter threshold control that prevents loud voices from booming out of the paging system's speakers. The limiter restricts the input signal to a preset level regardless of the input level. To set the limiter, follow the directions below.

1. Turn off the limiter by rotating the control fully clockwise.
2. Hold the telephone handset in a normal position and speak in a normal voice distinctly into the mouthpiece. Adjust the limiter control until the limiter active LED starts to come on.

The ZX3 module level controls can be adjusted without disturbing the limiter adjustment.

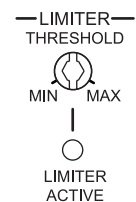

# Features & Operation

---

## Zones

The UTI312 offers up to twelve zones of paging. These zones are numbered 01 through 12 by default and do not require any programming, though they may be renumbered using the Flexible Dialing feature.

*To page to a zone:*

1. Dial the paging access number for your telephone system.
2. Listen for the confirmation tone (if enabled).
3. Dial the zone number. Default zone numbers require 2 digits to be dialed. Zones renumbered using Flexible Dialing must be dialed as programmed.
4. Listen for pre-announce tone (if enabled).
5. Make the page and hang up when finished.

To renumber a zone, see *Flexible Dialing* on page 22. It is possible to page to a zone that does not exist. An error tone will be heard by the calling party when this occurs. A disconnection from the system will occur when paging to a zone that is not installed in Station mode and when in Trunk mode if the Trunk Disconnect feature is enabled.

## Paging Zone Groups

Rather than page each zone separately, the UTI312 allows up to 24 paging zone groups to be programmed. These zone groups permit the user to program multiple paging zones into a single paging zone group. These zone groups are numbered \*01 through \*24 by default. These zone groups may be renumbered using Flexible Dialing. For information on programming and renumbering paging zone groups, refer to the *System Programming* section.

*To page to a paging zone group:*

1. Dial the paging access number for your telephone system.
2. Listen for the confirmation tone (if enabled).
3. Dial the \* key followed by the paging zone group number if a default paging zone group number is being used. An \* is not used when Flexible Dialing is enabled. Paging zone groups renumbered using Flexible Dialing must be dialed as programmed.
4. Listen for pre-announce tone (if enabled).
5. Make the page and hang up when finished.

It is possible to page to a zone group that is not installed. An error tone will be heard by the calling party when this occurs. A disconnection from the system will occur when paging to a zone that is not installed in Station mode and when in Trunk mode if the Trunk Disconnect feature is enabled.

## All-Call Zone Group

By default, the All-Call zone group is programmed to include all zones. It is necessary to dial 00 to access All-Call. The All-Call zone group can be programmed to include specific zones like other zone groups and may be disabled. For information on programming or disabling All-Call, refer to the *System Programming* section.

*To page to the All-Call zone group:*

1. Dial the paging access number for your telephone system.
2. Listen for the confirmation tone (if enabled).
3. Dial 00.
4. Listen for pre-announce tone (if enabled).
5. Make the page and hang up when finished.

## Auto Select Zone Group

Auto Select provides paging to a programmed zone group when the unit is accessed without having to enter any DTMF keys. This feature is useful when voice paging is always to all zones, but only certain zones are to receive tone trigger signals. No user-controlled zone selection is permitted for paging when this feature is enabled. Auto Select paging does not interfere with Override, Night Ring, Tone Trigger 1, and Tone Trigger 2 zone groups. For information on programming or disabling Auto Select, refer to the *System Programming* section.

To page to the Auto Select zone group:

1. Dial the paging access number for your telephone system.
2. Listen for pre-announce tone (if enabled).
3. Make the page and hang up when finished.

## Override Zone Group & Tone

By default, the Override zone group is programmed to include all zones. The Override feature gives the caller the ability to trigger an Override announcement in a programmed zone group. When Override is activated, a quad beep pre-announce tone will precede the announcement. The tone can be enabled or disabled (the default is enabled). This feature has the highest priority. See *System Programming* to program the Override zone group or to disable the tone.

## Night Ring Zone Group & Tone

By default, the Night Ring zone group is programmed to include all zones. The Night Ring feature gives the caller the ability to trigger a Night Ring tone in a programmed zone group. The Night Ring tone may be programmed to be a simulated ring or chime tone (the default is simulated ring). This tone is produced when either of the Night Ring inputs are activated. This feature is above Background Music and below Override, Tone Triggers 1 and 2, and Paging in the priority structure. See *System Programming* to program the Night Ring zone group and to choose the tone.

## Tone Trigger 1 & 2 Zone Groups & Tones

By default, the Tone Trigger zone groups are programmed to include all zones. The Tone Trigger feature gives the caller the ability to trigger a particular tone in a programmed zone group. This tone is activated when the Tone 1 or Tone 2 and C terminals are shorted together. A 3-second tone burst is the default setting for both Tone Triggers. These tones have the second highest priority after Override with Tone Trigger 1 having a higher priority than Tone Trigger 2.

Several tone options are available:

**2 - 7 second tone burst** - This is a tone burst that, once a momentary closure is detected at the tone trigger input, will sound for the set duration one time. The UTI312 will not respond to the tone trigger input while the tone is in progress. If the closure is still present at the tone trigger input upon completion of the tone, then the UTI312 will not sound the tone again until the closure is removed and applied again.

**Tone follow contact** - This is a tone burst that will sound continuously as long as a contact closure is present at the tone trigger input.

**Double chime tone** - This is a chime tone that will sound twice when a closure is detected at the tone trigger input. The UTI312 will not respond to the tone trigger input while the tone is in progress. If the closure is still present at the tone trigger input upon completion of the tone, the UTI312 will not sound the tone again until the closure is removed and applied again.

**Chime tone follow contact** - This is a chime tone that will sound continuously as long as a contact closure is present at the tone trigger input.

**Slow whoop follow contact** - This is a slow whoop tone that will sound continuously as long as a contact closure is present at the tone trigger input. Momentary contact will produce one cycle of slow whoop.

*Note: The volume level of these tones and all of the tones (with the exception of the Night Ring tone) are controlled by the Tone Level Control.*

## Code Call Zone Group & Tones

By default, the Code Call zone group is programmed to include all zones. The Code Calling feature gives the caller the ability to trigger a series of chime tones to a zone group. By default, Code Call is disabled. There are two types of code calling: pattern and echo.

### Pattern Code Calling

Pattern code calling sounds a factory-set pattern of chime tones in response to a DTMF key selection by the caller. There are 10 patterns available. The caller presses the # key and then a single DTMF key to select the pattern. The unit will give a confirmation beep and then proceed with the code call. For example, if the caller wanted the code call to have three chimes, followed by a one-second pause, and then a single chime, the caller would dial #7. The calling phone can be hung up following the selection. The code call will not be heard on the phone.

### Pattern Code Call Table

0 = CC	5 = CC_CC	<b>Key/Legend</b>
1 = C_C	6 = CC_CCC	C = Chime Tone
2 = C_CC	7 = CCC_C	_ = pause
3 = C_CCC	8 = CCC_CC	
4 = CC_C	9 = CCC_CCC	

### Echo Code Calling

Echo code calling sounds chime tones that correspond to a 2-digit entry made by the caller with each digit representing the number of chimes. The caller presses the # key first and then any two DTMF keys. For example, if the caller wanted three chimes followed by a 1-second pause and then followed by two more chimes, the caller would dial #32.

### Code Call Playing

By default, code calling triggers one series of chime tones (Code Call 1 Play). Code calling can be programmed to repeat the series of chime tones once (Code Call 1 Repeat) or twice (Code Call 2 Repeat). There is a three-second delay between series.

There is one selection permitted per access. In Station Mode the unit will drop the line after the code call is complete. In Page Port VOX mode the caller is permitted to make another selection after the first code call is complete. In Trunk or Page Port Contact mode, a caller may call into the unit, but the unit will not acknowledge the call until the code call is complete. The code call is not audible in the handset.

The type of code calling, the number of times the tones are played, and the zone group are programmable. See *System Programming* for more information on programming code calling.

## AUX Relay Contact

The UTI312 allows the installer to program a number of different parameters to control the way in which the UTI312 AUX relay contact activates. The UTI312 allows programming of which input events (Override, Tone Trigger, Page, and Night Ring) it will respond to, whether it will respond to the event only (Event-Driven Mode) or to a combination of the event and its place in the priority structure (Priority-Driven Mode), and if the contact will respond during the event (No Delay) or after the event ends (Delay). See *System Programming* section for more information on the AUX Relay Contact.

## Flexible Dialing

The default dialing plan requires the caller to dial two digits for accessing zones or an \* followed by 2 digits for accessing paging zone groups.

Using Flexible Dialing, the dialing digit length and the access codes for zones and paging zone groups can be renumbered to suit the needs of the user. The digit length for Flexible Dialing can be set to 2, 3, 4 or 5 digits. Flexible Dialing can be enabled or disabled in programming mode. When disabled, programming is not lost, but remains in memory. See *System Programming* section for more information on Flexible Dialing.

## Confirmation Tone

This tone is heard by the calling party, but not over the paging speakers. It is a beep tone and can be disabled.

## Pre-Announce Tone

This tone is heard at the speakers being paged and by the calling party. It is selectable as either a chime or beep (default). The pre-announce tone can be inhibited.



## Dialing Time-out

Dialing Time-out can be enabled or disabled and by default is enabled. When enabled, the dialing time-out starts as soon as the unit becomes active. The dialing time-out lasts 15 seconds and is reset with every DTMF tone until the string is complete. If no DTMF is detected within those 15 seconds, there will be an error tone. This feature is only valid in RUN mode, not PROGRAM mode. When dialing time-out is disabled, the unit will follow the default timer.

## DTMF Block

If enabled, DTMF Block suppresses DTMF keys so that only a short portion of the tone can be heard over the speakers during a page. Disabling DTMF Block allows a user to pass DTMF keys to external equipment connected to the zone outputs during a page.

## Trunk Disconnect

The UTI312 includes a Trunk Disconnect feature. The purpose of the Trunk Disconnect feature is to release the UTI312 from the trunk port in the event a user does not hang up the phone properly after making a page. If the UTI312 does not detect voice for the interface VOX time-out period, or if the interface default timer expires, the UTI312 will attempt to release from the trunk by momentarily interrupting the talk battery. When using the Trunk Disconnect feature, the PBX must have disconnect supervision available on the trunk port being used. The Trunk Disconnect feature is disabled by default.

## Timers

### *Default Timer*

If the UTI312 is connected to a PBX station port, or a trunk port with the Trunk Disconnect feature enabled, you can set the maximum page duration (default timer). The factory setting for this timer is 30 seconds and can be adjusted in 10 second increments up to 990 seconds. This timer can be inhibited. See *System Programming* for more information on setting or inhibiting the Default Timer.

### *VOX Timer*

If the UTI312 is connected to a station port, page port VOX, or trunk port with the Trunk Disconnect feature enabled, you can set the time duration for the maximum silence duration time-out. The factory setting is 6 seconds and can be adjusted in 1 second increments up to 9 seconds. This timer can be inhibited. See *System Programming* for more information on setting or inhibiting the VOX Timer.

## Calling Party Controlled Disconnect

When in station mode, the UTI312 will immediately disconnect when it detects a CPC (calling party control) signal. A CPC signal is a loss of loop current for greater than 300mS. It is typically issued by the PBX or CO immediately after the calling party hangs up, but can be delayed for up to 10 seconds depending on the equipment issuing the signal. The UTI312's detection and disconnection is not defeatable and is the only way to disconnect from a station port if both the Default and VOX Timers are inhibited.

## Setup Tone

This tone can be activated only when the system is in Program mode (set with Run/Program switch). It is an all-call interrupted tone that can be used by the installer to check speaker operation and to set the operational level of the speakers.

*Note: The volume level of this tone is controlled by the Tone Level Control.*

## Reset Default Values

A feature code is available to reset the UTI312 system to the original factory default values. Wait for a confirmation tone before hanging up. This will not clear any flexible dialing numbers that have been programmed into the system.

## Priority Levels

The following list indicates the priority level operation of the UTI312 features.

Highest	Override
	Tone Trigger 1
	Tone Trigger 2
	Paging
	Night Ring
Lowest	Background Music



# System Programming

System programming lets you set certain UTI312 options and tone features using the DTMF keys of a telephone. All programming is accomplished through the Override jack on the UTI312.

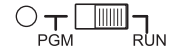

To program the UTI312 system, follow these instructions:

1. Place the PROGRAM/RUN switch to the PROGRAM position. The green LED will illuminate.
2. Access the UTI312 override port (either use a single 2500-type telephone or Test Set).
3. You will hear 3 beep tones indicating access to the programming mode.
4. Dial the Feature Code and any required input data for the option you wish to program. See the *Feature Codes & Defaults* charts.
5. Press the [#] key to store the programming data. If you don't dial the [#], then the data is not stored. A double beep will sound to confirm the entry. Continue with the next Feature Code immediately after the confirming double beep. If the information is not accepted, you will hear a busy tone. In this case, you must hang up, check the code and the data, then re-access the system and try again.
6. Once you have finished all programming, you must first hang up the programming phone and then place the Program/Run switch in the Run position. The green LED will go out.



## Paging Zone Groups

To program a paging zone group, dial the zone group feature code followed by the zone numbers to be included in the paging zone group and a # key. For example, to program zones 1 through 3 to paging zone group 1, dial \*01010203#.

To clear zones from a zone group, dial the feature code for that particular zone group followed by the # key with no zone data. For example, to clear all zones from zone group one, dial \*01#.

When programming paging zone groups, the unit uses the default access codes for zones and paging zone groups (01 through 12 for zones and \*01 through \*24 for paging zone groups) rather than any renumbered access codes using Flexible Dialing.

It is possible to program a zone that is not installed into a zone group.

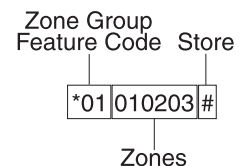

## All-Call Zone Group

By default, the All-Call zone group is set to all zones. To program the All-Call zone group, dial the All-Call zone group feature code (\*97) followed by the zone numbers to be included in the zone group. For example, to program zone 1, zone 2, and zone 9 to the All-Call zone group, dial \*97010209#.

To return the All-Call zone group to All-Call, dial the feature code followed by 00# (\*9700#).

To disable All-Call, clear all zones from its zone group by dialing the feature code followed by the # key. Example: \*97#.

## Auto Select Zone Group

By default, the Auto Select zone group is set to no zones. To program the Auto Select zone group, dial the Auto Select zone group feature code (\*96) followed by the zone numbers to be included in the zone group. For example, to program zone 1, zone 3, and zone 12 to the Auto Select zone group, dial \*96010312#.

Auto Select is enabled by programming zones into its zone group. Remember, no individual zone or zone group selection is permitted for paging when this feature is enabled.

To disable Auto Select, clear all zones from its zone group by dialing the feature code followed by the # key. Example: \*96#.

## Tone Zone Groups

In addition to paging zone groups, there are five additional zone groups, each with an associated tonal function. These are Override zone group, Night Ring zone group, Tone Trigger 1 zone group, Tone Trigger 2 zone group, and Code Call zone group. By default, these zone groups are set to all zones.

Each is programmed in the same manner as the paging zone groups, only with a different feature code. For example, to program zones to the Tone Trigger 1 zone group, dial the Tone Trigger 1 zone group feature code (\*91), followed by the zone numbers to be included in the zone group, followed by the # key to store the data.

To return these zone groups to All-Call, dial their respective feature code followed by 00# (\*9700#).

To clear zones from these zone groups, dial the feature code for that particular zone group followed by the # sign. For example, to clear all zones from Tone Trigger 1 zone group, dial \*91#.

What differentiates these zone groups from the paging zone groups is the tone associated with them. The tone for each of these zone groups can also be programmed along with the zones. For example, to program Tone Trigger 1 for zone 1, zone 3, zone 5, and zone 7 with the chime follow contact tone (feature code 029), dial \*9101030507#029#.

For each particular zone group's default settings and options, refer to the *Feature Codes and Defaults* table on pages 23-26.

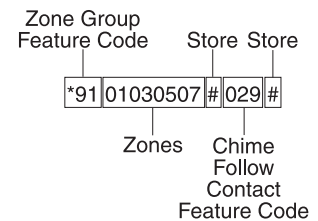

## Code Calling

Code calling triggers a series of chime tones to the Code Call zone group. There are two types of code calling: pattern and echo.

### Pattern Code Call

Pattern code calling sounds a factory-set pattern of chime tones in response to a DTMF selection by the caller. There are 10 patterns available. To program the Code Call zone group for pattern code calling, dial feature code 041 followed by the # key.

### Echo Code Call

Echo code calling sounds chime tones that correspond to a 2-digit entry made by the caller with each digit representing the number of chimes. To program the Code Call zone group for echo code calling, dial feature code 042 followed by the # key.

### Code Call Playback

By default, code calling triggers a series of chime tones to a zone or zone group one time (Code Call 1 Play). Code calling can be programmed to playback the series of chime tones once (Code Call 1 Repeat) or twice (Code Call 2 Repeat) for a total of three executions. To program code calling for 1 Repeat or 2 Repeat, dial the feature code (044 or 045) followed by the # key. Ex.: 044# for Code Call 1 Repeat.

The code call feature can be enabled and disabled without losing any of the programmed data associated with it.

## DTMF Block

DTMF Block, to suppress DTMF tone pass-through, can be enabled (feature code 068) or disabled (feature code 069).

## Timers

### Default Timer

To change the default timer, enter the feature code 050 and the new 2-digit number corresponding to the time desired followed by the # key. The 2-digit number represents default time in multiples of 10 seconds. (Example: 03 = 30 seconds; 12 = 120 seconds.) Ex.: 05003# for 30 seconds. If you wish to inhibit the default timer, enter "00" for the time data.

### VOX Timer

To set the time duration for the VOX time-out, enter the feature code 051 followed by a single digit from 1 to 9, corresponding to 1 to 9 seconds, followed by the # key. Ex.: 0515# for 5 seconds. To inhibit the timer, enter the Feature Code followed by "0".

*Note: If both the default and VOX timers are inhibited, the only way to release the UTI312 from a station line is through the use of a Calling Party Control (CPC) pulse of 300 ms or longer.*

## **AUX Relay Contact**

The UTI312 allows the installer to program a number of different parameters to control the way in which the UTI312 AUX relay contact activates. The UTI312 allows programming of which input events (Override, Tone Trigger 1 and 2, Page, and Night Ring) it will respond to, whether it will respond to the event only (Event-Driven Mode) or to a combination of the event and its place in the priority structure (Priority-Driven Mode), and if the contact will respond during the event (No Delay) or after the event ends (Delay).

### **Event Enable/Disable**

The UTI312 monitors for 5 types of input events: Override, Tone Trigger 1, Tone Trigger 2, Page and Night Ring. When one of these inputs is activated, the UTI312 detects that as a particular event. Through programming, the installer can decide which of these 5 events the UTI312 will allow to activate the AUX relay. Setting the event to Enable allows the AUX contact to respond to that event.

For example, if the application requires that the AUX relay contacts respond only when the Night Ring input is active, the installer would enable the Night Ring event and disable all other events (Override, Tone Trigger 1 & 2, and Page).

It is possible to enable multiple events. In this case the OR events are logically stringed together. For example, if the Override and Tone Trigger 1 events are both enabled, the AUX contacts will activate when the Override input OR the Tone Trigger input OR both of them become active. If all 5 events were enabled, the contacts would activate any time the UTI312 was doing anything but sitting idle (this is the factory default setting).

### **Event-Driven/Priority-Driven Mode**

There are applications where the AUX relay contacts should activate regardless of what else may be going on in the UTI312 (Event-Driven Mode) and other times when it should activate so long as there is not another higher priority input active (Priority-Driven Mode).

For example, an application requires that a strobe flash for as long as the Night Ring line rings. This is accomplished by selecting the Event-Driven Mode and disabling all the events except Night Ring. In this configuration, the AUX relay contacts will activate whenever the Night Ring line becomes active. This action is independent of whatever else may be going on in the UTI312. Therefore, even though a page may be occurring that suppresses the Night Ring audio tone, the AUX relay will still cause the strobe to flash.

Likewise, there may be applications where it is desirable to have a higher priority event deactivate the AUX relay operation even though a lower priority event is still on going. For example, suppose the strobe above was specified to flash only when the Night Ring audio is produced. This is accomplished by selecting the Priority-Driven Mode instead of the Event-Driven Mode. In this case if the Night Ring audio is interrupted by a higher priority input, like the Page input, the AUX relay will be deactivated for the duration of that event. The AUX relay will become active again if the lower priority (Night Ring) event is still active when the higher priority event finishes.

### **Delay/No Delay**

It is sometimes desirable for the AUX relay to activate immediately after an event rather than during an event. By selecting the Delay programming option, the contacts activate immediately after the enabled events end. The contacts will activate for 1 second and then deactivate.

For example, a specification requires that after a tone has been produced an audio message is to be played that is triggered by a momentary contact closure. To accomplish this, the tone trigger 1/2 event is enabled and the Delay option is selected. In this configuration the AUX relay contacts trigger the message playback device at the end of the tone.

Here are some illustrative examples:

### Example 1: Emergency Tone/Emergency Announcement Bypass

*The Tone Trigger 1 and Override inputs are used to provide emergency tones and live emergency announcements and when this happens any local attenuators are to be bypassed to ensure that emergency announcements can be heard.*

The AUX relay contacts will signal the attenuators to go into the bypass mode. Program the UTI312 with the Override and Tone Trigger events enabled and all others disabled. In this case the UTI312 can be in Event-Driven or Priority-Driven Mode since the application only involves the two highest priority inputs. Nevertheless, set the operation for Priority-Driven mode with the No Delay option since the AUX relay contacts need to activate during the event. Now, when either the Tone Trigger OR Override input becomes active the AUX relay will signal the attenuators to bypass. During normal paging, Tone Trigger 2 or Night Ring, the attenuators still control the audio level of their associated speakers.

		Enabled/ Disabled	Code
Event	Override	Enabled	071
	Tone Trigger 1	Enabled	073
	Tone Trigger 2	Disabled	074
	Page	Disabled	076
	Night Ring	Disabled	078
Mode	Event	Disabled	-
	Priority	Enabled	082
Delay	Delay	Disabled	-
	No Delay	Enabled	081

### Example 2: Strobes Flash to Announce Night Ring

*Strobes throughout a facility are to flash whenever a night line rings to provide a visual alert of the ringing line, regardless of whether or not the night ring tone can be heard.*

Program the UTI312 with the Night Ring event enabled and all other events disabled. Select the Event-Driven Mode since the strobes are to flash when the Night Ring line is ringing independent of whatever other events are taking place with the UTI312. No Delay should be selected so that the AUX relay contacts activate during the event. The strobes will flash for as long as the night line rings. If a Page, Tone Trigger or Override page occurs during this event, the Night Ring tone will stop, but the strobes will continue to flash. The strobes stop only when the night line stops ringing.

		Enabled/ Disabled	Code
Event	Override	Disabled	070
	Tone Trigger 1	Disabled	072
	Tone Trigger 2	Disabled	074
	Page	Disabled	076
	Night Ring	Enabled	079
Mode	Event	Enabled	083
	Priority	Disabled	-
Delay	Delay	Disabled	-
	No Delay	Enabled	081

### Example 3: Message Playback Following Tone

*A message is to be played immediately after a chime tone is produced.*

In this application the Tone Trigger 1 input will be activated to cause the chime tone (one of the UTI312's selectable tones). After the tone finishes the AUX relay contacts will trigger an audio playback device with a 1-second contact closure pulse. Program the UTI312 with the Tone Trigger 1 event enabled and all other events disabled. Select the Event-Driven Mode (see below about issue using Priority-Driven Mode in this case). Select the Delay option so that the contact will pulse immediately after the event finishes. Now, whenever Tone Trigger 1 is activated a message will play immediately after the tone stops. A good way to get the message into the paging system is to use the Override input if it is available.

		Enabled/ Disabled	Code
Event	Override	Disabled	070
	Tone Trigger 1	Enabled	073
	Tone Trigger 2	Disabled	074
	Page	Disabled	076
	Night Ring	Disabled	078
Mode	Event	Enabled	083
	Priority	Disabled	-
Delay	Delay	Enabled	080
	No Delay	Disabled	-

### Priority-Driven Mode Issues

Care should be taken when using the Priority-Driven Mode because it can cause some unexpected results. When the event selected to control the AUX relay is interrupted by a higher priority event that is not enabled, the UTI312 will consider that the AUX relay event has finished even if it hasn't, and the relay will change states. If the Delay option is selected, then the UTI312 will pulse the AUX relay contacts. If the AUX relay event is still active after the high priority event is completed, the AUX relay will again activate. This operation can lead to multiple changes in the relay state (when No Delay is selected) or multiple pulsations of the AUX relay (if the Delay option is selected). Care should be taken in using the Priority-Driven Mode, especially when low priority events are enabled.

## Flexible Dialing

Flexible Dialing permits the user to custom configure the digit length and the access codes for zones and paging zone groups.

The digit length for Flexible Dialing can be set to 2, 3, 4 or 5 digits. When Flexible Dialing is enabled, zones and paging zone groups are the same digit length and no \* is used for accessing zone groups. Duplicate Flexible Dialing numbers are not permitted.

*Note: The digit length cannot be changed unless the user-programmed access codes have been cleared first.*

When Flexible Dialing is enabled, a zone or paging zone group cannot be accessed until a Flexible Number has been assigned to it.

When Flexible Dialing is disabled, the unit uses the default access codes for zones and paging zone groups (01 through 12 for zones and \*01 through \*24 for paging zone groups). Disabling Flexible Dialing will not clear any user-programmed access codes or the digit length setting. Flexible Dialing does not need to be enabled to program the digit length or the new access codes for zones and paging zone groups. However, the new access codes are functional only in Run mode and cannot be accessed in Program mode. When programming paging zone groups, the default zone groups (\*01 through \*24) must be used.

To program the UTI312 system for Flexible Dialing, follow these instructions:

1. Use the table below to list and cross-reference the new Flexible Dialing Plan numbers before programming.
2. If this is the first time this feature has been programmed, then begin by setting the digit length (codes 062-065). If this is not the first time this feature has been programmed, then begin by clearing all user-programmed access codes (code 900#) and then set the digit length.
3. Dial the Feature Code (codes 101-224) and then the desired Flexible Dialing Number for that particular zone or paging zone group.
4. Press the [#] key to store the programming data. If you don't dial the [#] key, then the data is not stored. A double beep will sound to confirm the entry.
5. When finished programming all of the Flexible Dialing Numbers for the zones and the paging zone groups, enable Flexible Dialing (code 061).
6. Once you have finished all programming, you must first hang up the programming phone and then place the Program/Run switch in the Run position. The green LED will go out.

## Flexible Dialing Reference Chart

Zones	Flexible Dialing #	Paging Zone Groups	Flexible Dialing #	Paging Zone Groups	Flexible Dialing #
Zone 1		Zone Group 1		Zone Group 13	
Zone 2		Zone Group 2		Zone Group 14	
Zone 3		Zone Group 3		Zone Group 15	
Zone 4		Zone Group 4		Zone Group 16	
Zone 5		Zone Group 5		Zone Group 17	
Zone 6		Zone Group 6		Zone Group 18	
Zone 7		Zone Group 7		Zone Group 19	
Zone 8		Zone Group 8		Zone Group 20	
Zone 9		Zone Group 9		Zone Group 21	
Zone 10		Zone Group 10		Zone Group 22	
Zone 11		Zone Group 11		Zone Group 23	
Zone 12		Zone Group 12		Zone Group 24	

# Feature Codes & Defaults

	Feature	Feature Code	Data	Default
<b>Confirmation Tone</b>	Confirmation Tone Disable	001		002
	Confirmation Tone Enable	002		
<b>Pre-Announce Tone</b>	Pre-Announce Disable	003		005
	Pre-Announce Beep	004		
	Pre-Announce Chime	005		
<b>Dialing Time-out</b>	Dialing Time-out Disable	012		013
	Dialing Time-out Enable	013		
<b>Trunk Disconnect</b>	Trunk Disconnect Disable	014		014
	Trunk Disconnect Enable	015		
<b>Timer</b>	Default Timer	050	00-99	03 <sup>†</sup>
	VOX Timer	051	0-9	6 <sup>††</sup>
<b>DTMF</b>	DTMF Block Disable	068		069
	DTMF Block Enable	069		
<b>Override</b>	Override Zone Group	*95	Zones	All-Call
	Override Tone Disable	008		009
	Override Tone Enable	009		
<b>Night Ring</b>	Night Ring Zone Group	*93	Zones	All-Call
	Night Ring Simulated Ring	016		016
	Night Ring Chime	017		
<b>Tone Trigger 1</b>	Tone Trigger 1 Zone Group	*91	Zones	All-Call
	Slow Whoop Follow Contact	020		023
	Tone Follow Contact	021		
	2-Second Tone	022		
	3-Second Tone	023		
	4-Second Tone	024		
	5-Second Tone	025		
	6-Second Tone	026		
	7-Second Tone	027		
	Double Chime	028		
Chime Follow Contact	029			
<b>Tone Trigger 2</b>	Tone Trigger 2 Zone Group	*92	Zones	All-Call
	Slow Whoop Follow Contact	030		033
	Tone Follow Contact	031		
	2-Second Tone	032		
	3-Second Tone	033		
	4-Second Tone	034		
	5-Second Tone	035		
	6-Second Tone	036		
	7-Second Tone	037		
	Double Chime	038		
Chime Follow Contact	039			

<sup>†</sup> The data digits represent time in 10's of seconds, i.e. "01" = 10 seconds. Entering "00" will disable the timer.

<sup>††</sup> This single data digit indicates VOX delay time in seconds. Entering "0" will disable the timer.

	Feature	Feature Code	Data	Default
<b>Code Call</b>	Code Call Zone Group	*94	Zones	All-Call
	Code Call Disable	040		040
	Code Call Pattern	041		
	Code Call Echo	042		
	Code Call 1 Play	043		043
	Code Call 1 Repeat	044		
	Code Call 2 Repeat	045		
<b>Special Zone Groups</b>	Auto Select Zone Group	*96	Zones	No Zones
	All-Call Zone Group	*97	Zones	All Zones
<b>Paging Zone Groups</b>	Zone Group 1	*01	Zones	None
	Zone Group 2	*02	Zones	None
	Zone Group 3	*03	Zones	None
	Zone Group 4	*04	Zones	None
	Zone Group 5	*05	Zones	None
	Zone Group 6	*06	Zones	None
	Zone Group 7	*07	Zones	None
	Zone Group 8	*08	Zones	None
	Zone Group 9	*09	Zones	None
	Zone Group 10	*10	Zones	None
	Zone Group 11	*11	Zones	None
	Zone Group 12	*12	Zones	None
	Zone Group 13	*13	Zones	None
	Zone Group 14	*14	Zones	None
	Zone Group 15	*15	Zones	None
	Zone Group 16	*16	Zones	None
	Zone Group 17	*17	Zones	None
	Zone Group 18	*18	Zones	None
	Zone Group 19	*19	Zones	None
	Zone Group 20	*20	Zones	None
	Zone Group 21	*21	Zones	None
	Zone Group 22	*22	Zones	None
	Zone Group 23	*23	Zones	None
	Zone Group 24	*24	Zones	None
<b>AUX Relay</b>	Override Disable	070		
	Override Enable	071		071
	Tone Trigger 1 Disable	072		
	Tone Trigger 1 Enable	073		073
	Tone Trigger 2 Disable	074		
	Tone Trigger 2 Enable	075		075
	Page Disable	076		
	Page Enable	077		077
	Night Ring Disable	078		
	Night Ring Enable	079		079
	Delay	080		
No Delay	081		081	
Priority-Driven	082			
Event-Driven	083		083	



	Feature	Feature Code	Data	Default
<b>Flexible Dialing</b>	Flexible Dialing Disable	060		060
	Flexible Dialing Enable	061		
	2-Digit Flexible	062		
	3-Digit Flexible	063		
	4-Digit Flexible	064		
	5-Digit Flexible	065		
	Clear Flexible Numbers	900		
<b>Renumber Zones</b>	Zone 1	101	Flex #	None
	Zone 2	102	Flex #	None
	Zone 3	103	Flex #	None
	Zone 4	104	Flex #	None
	Zone 5	105	Flex #	None
	Zone 6	106	Flex #	None
	Zone 7	107	Flex #	None
	Zone 8	108	Flex #	None
	Zone 9	109	Flex #	None
	Zone 10	110	Flex #	None
	Zone 11	111	Flex #	None
	Zone 12	112	Flex #	None
<b>Renumber Zone Groups</b>	Zone Group 1	201	Flex #	None
	Zone Group 2	202	Flex #	None
	Zone Group 3	203	Flex #	None
	Zone Group 4	204	Flex #	None
	Zone Group 5	205	Flex #	None
	Zone Group 6	206	Flex #	None
	Zone Group 7	207	Flex #	None
	Zone Group 8	208	Flex #	None
	Zone Group 9	209	Flex #	None
	Zone Group 10	210	Flex #	None
	Zone Group 11	211	Flex #	None
	Zone Group 12	212	Flex #	None
	Zone Group 13	213	Flex #	None
	Zone Group 14	214	Flex #	None
	Zone Group 15	215	Flex #	None
	Zone Group 16	216	Flex #	None
	Zone Group 17	217	Flex #	None
	Zone Group 18	218	Flex #	None
	Zone Group 19	219	Flex #	None
	Zone Group 20	220	Flex #	None
	Zone Group 21	221	Flex #	None
	Zone Group 22	222	Flex #	None
	Zone Group 23	223	Flex #	None
	Zone Group 24	224	Flex #	None

	Feature	Feature Code
<b>Test Mode</b>	(factory use) Test Mode	990
<b>Reset</b>	Reset Default	999
<b>Setup Tone</b>	Turn On Turn Off	000 Hang Up

Leave phone off hook during testing.

### Notes to Feature Codes

To clear zones from zone groups, dial the feature code for that particular zone group followed by the # sign. For example, to clear all zones from Zone Group 1, dial \*01# or to clear all zones from Tone Trigger 1 zone group, dial \*91#.

By default, All-Call, Tone Trigger 1, Tone Trigger 2, Night Ring, Code Call, and Override zone groups are programmed for All-Call. To return these zone groups to All-Call, dial the feature code followed by 00#. For example, to return Tone Trigger 1 zone group to All-Call, dial \*9100#.

# Specifications

---

Input Impedance:	600 ohms (nominal)
Input Level:	-10 dBm (nominal)
VOX Sensitivity:	-30 dBm
Background Music Input Impedance:	20k ohms
Music Input Level:	-10 dBm (nominal)
Output Level:	-10 dBm (nominal)
Output Impedance:	8 ohms
Speaker Drive Capacity:	150 per zone
Timer Duration (both defeatable):	Default: 10 seconds to 990 seconds VOX: 1 second to 9 seconds
CPC Disconnect:	pulse greater than 300 mS
ZX3 Contact Closure:	2A @ 30V AC 0.5A @ 125V AC
AUX Contact Closure:	2A @ 30V DC 0.6A @ 125V AC
DC Output:	1A @ 24V DC
Voltage:	120V AC
Current:	0.75A
Temperature:	0 to 104° F /-18° to 40° C
Humidity:	0 to 85% non-precipitating
Approvals:	Listed to UL Standard 60950 for U.S. and Canada; FCC Part 68; Industry Canada CS-03; FCC Part 15
Dimensions:	16- <sup>3</sup> / <sub>8</sub> " W x 3- <sup>1</sup> / <sub>2</sub> " H x 4- <sup>7</sup> / <sub>8</sub> " D 19" W x 3- <sup>1</sup> / <sub>2</sub> " H x 4- <sup>7</sup> / <sub>8</sub> " D (with mounting flanges)

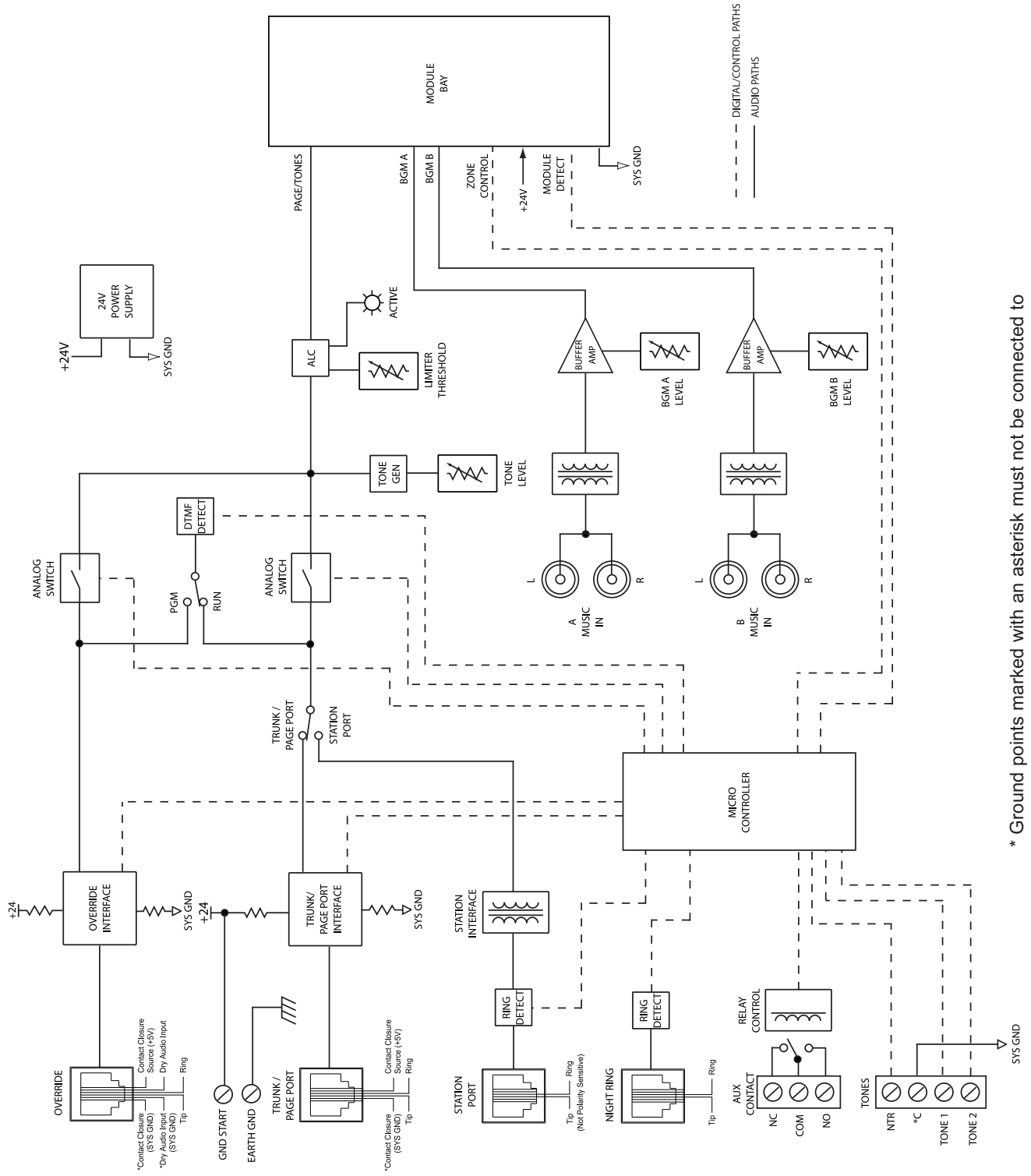

\* Ground points marked with an asterisk must not be connected to Earth Ground when GND ST terminal is connected to Earth Ground.

# Block Diagram, UTI312

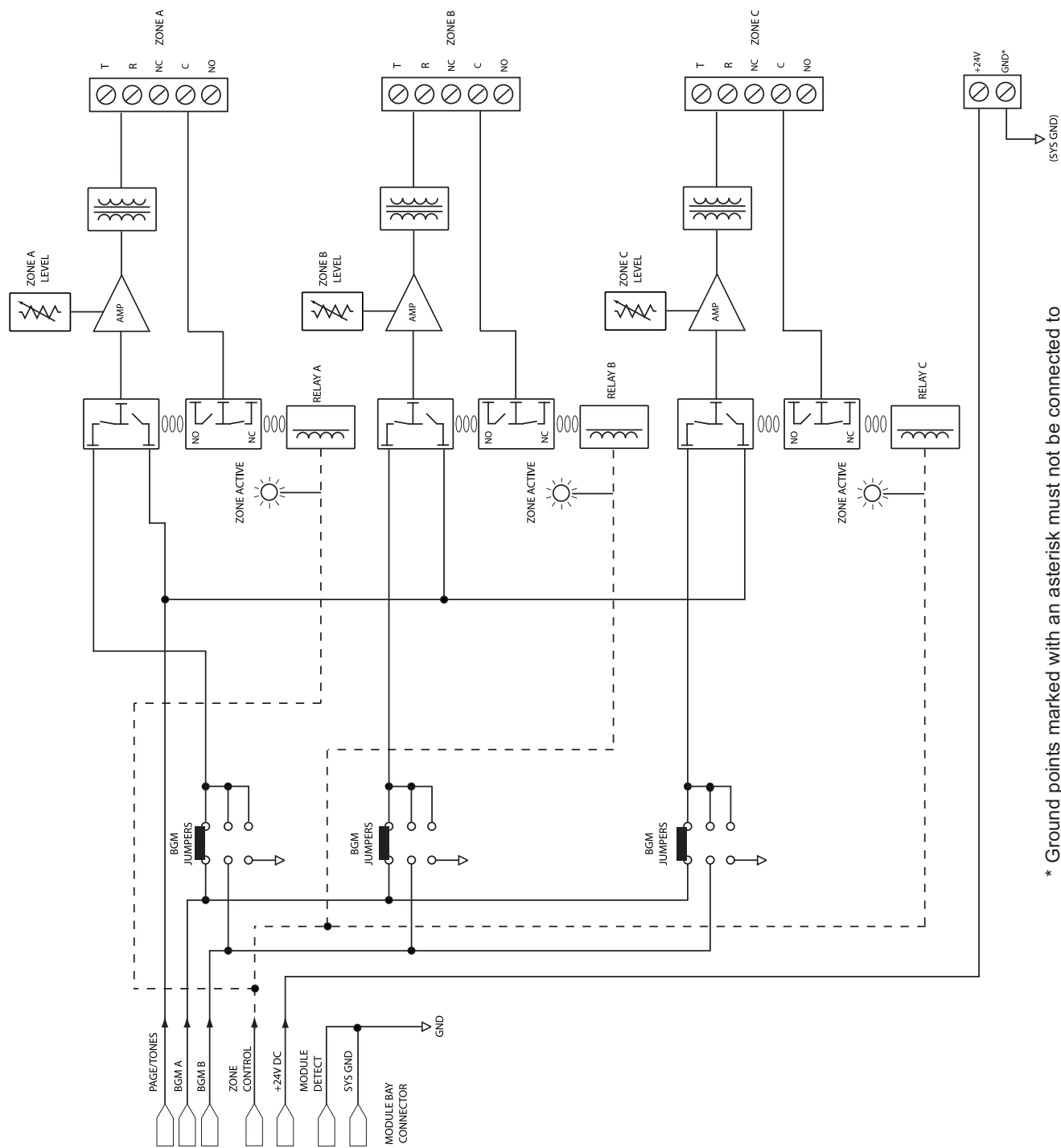

\* Ground points marked with an asterisk must not be connected to Earth Ground when GND ST terminal is connected to Earth Ground.

# Block Diagram, ZX3

The **Bogen UTI312 Zone Controller** is warranted to be free from defects in material and workmanship for two (2) years from the date of sale to the original purchaser. Any part of the product covered by this warranty that, with normal installation and use, becomes defective (as confirmed by Bogen upon inspection) during the applicable warranty period, will be repaired or replaced by Bogen, at Bogen's option, provided the product is shipped insured and prepaid to: Bogen Factory Service Department, 50 Spring Street, Ramsey, NJ 07446, USA. Repaired or replacement product will be returned to you freight prepaid. This warranty does not extend to any of our products that have been subjected to abuse, misuse, improper storage, neglect, accident, improper installation or have been modified or repaired or altered in any manner whatsoever, or where the serial number or date code has been removed or defaced.

**THE FOREGOING LIMITED WARRANTY IS BOGEN'S SOLE AND EXCLUSIVE WARRANTY AND THE PURCHASER'S SOLE AND EXCLUSIVE REMEDY. BOGEN MAKES NO OTHER WARRANTIES OF ANY KIND, EITHER EXPRESS OR IMPLIED, AND ALL IMPLIED WARRANTIES OF MERCHANTABILITY OR FITNESS FOR A PARTICULAR PURPOSE ARE HEREBY DISCLAIMED AND EXCLUDED TO THE MAXIMUM EXTENT ALLOWABLE BY LAW.** Bogen's liability arising out of the manufacture, sale or supplying of products or their use or disposition, whether based upon warranty, contract, tort or otherwise, shall be limited to the price of the product. **IN NO EVENT SHALL BOGEN BE LIABLE FOR SPECIAL, INCIDENTAL OR CONSEQUENTIAL DAMAGES (INCLUDING, BUT NOT LIMITED TO, LOSS OF PROFITS, LOSS OF DATA OR LOSS OF USE DAMAGES) ARISING OUT OF THE MANUFACTURE, SALE OR SUPPLYING OF PRODUCTS, EVEN IF BOGEN HAS BEEN ADVISED OF THE POSSIBILITY OF SUCH DAMAGES OR LOSSES.** Some States do not allow the exclusion or limitation of incidental or consequential damages, so the above limitation or exclusion may not apply to you. This warranty gives you specific legal rights, and you may also have other rights which vary from State to State.

Products that are out of warranty will also be repaired by the Bogen Factory Service Department – same address as above or call 201-934-8500. The parts and labor involved in these repairs are warranted for 90 days when repaired by the Bogen Factory Service Department. All shipping charges in addition to parts and labor charges will be at the owner's expense. All returns require a Return Authorization number. For most efficient warranty or repair service, please include a description of the failure.

12/2008



**BOGEN**<sup>®</sup>  
COMMUNICATIONS, INC.  
[www.bogen.com](http://www.bogen.com)