

Speaker Wall Mount

CyberData

The IP Endpoint Company

The Speaker Wall Mount supports most CyberData SIP, InformaCast Enabled or Syn-Apps speakers for easy indoor installation on a wall. The front plate is angled downward to maximize sound dispersion.

Features:

- Easy wall installation
- Mounting kit included
- Electrogalvanized steel construction
- Top and bottom cable channels

Related Products:



011394 SIP Speaker



011398 SIP
Talk-Back Speaker



011396 InformaCast@
Enabled Speaker



011400 InformaCast@
Enabled Talk-Back Speaker



011105 Syn-Apps
Enabled Speaker



011121 Auxiliary
Analog Speaker



Specifications

Dimensions*	10.4 in. [264 mm] Length 8 in. [204 mm] Width (Top) 4 in. [102 mm] Width (Bottom) 12.6 in. [321 mm] Height
-------------	---

Weight	2.17 lbs [.98 kg]
Boxed Weight	5.8 lbs. [2.63 kg]

Compliance	RoHS Compliant
------------	----------------

Warranty	5 Years Limited
----------	-----------------

Part Number/Color	011152/RAL 9003 (Signal White)
-------------------	--------------------------------

*Dimensions are measured from the perspective of the product being upright with the front of the product facing you.

Speaker Wall Mount

Typical Installation - Exploded View

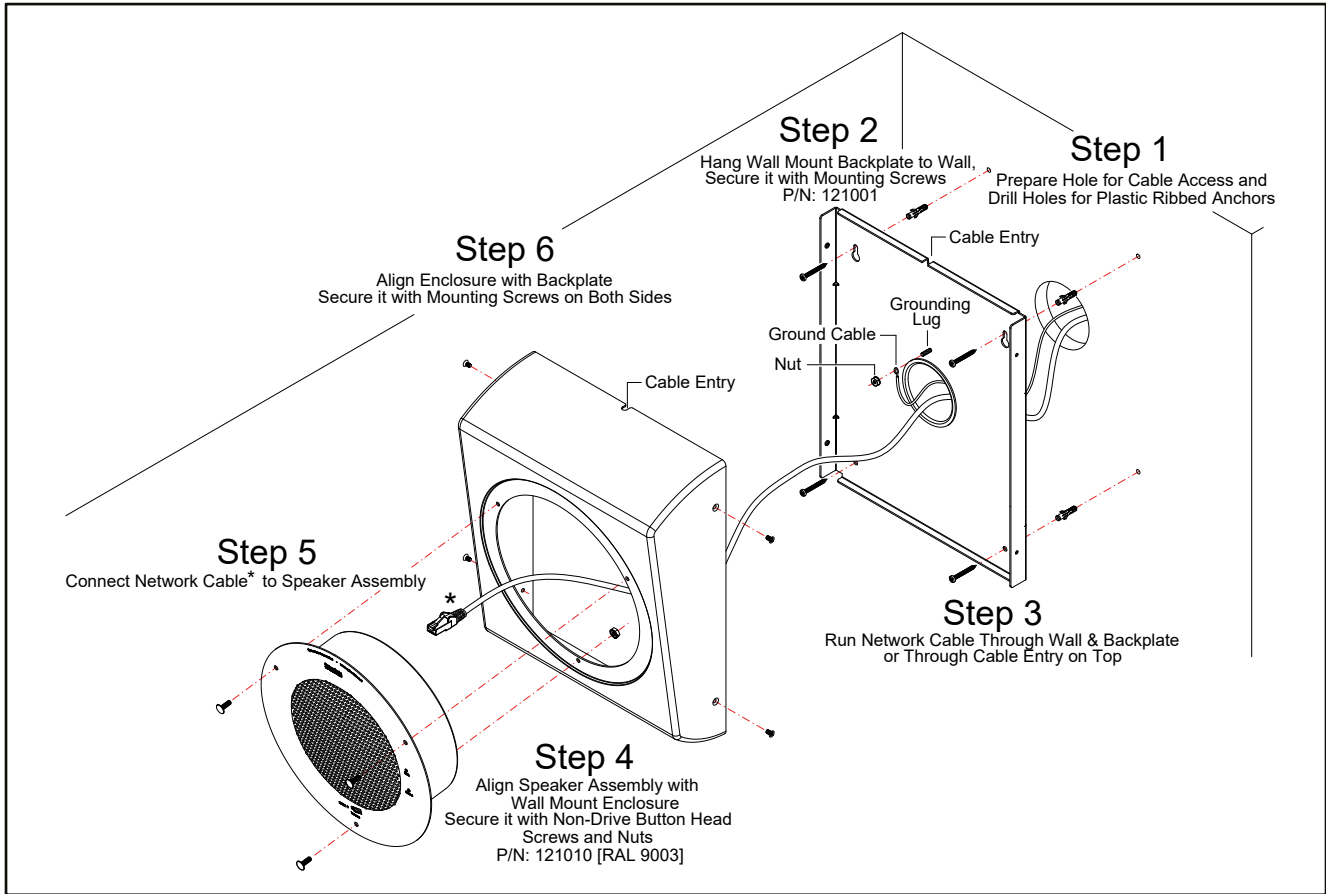

Overall Dimensions

