

2-Port PoE Gigabit Switch

The CyberData 2-Port PoE Gigabit Switch is designed to expand a single PoE network connection into one or two PoE network ports.

Pass through PoE power

The CyberData 2-Port PoE Gigabit Switch is powered from a single 802.3at or 802.3af network switch or power source and passes that power through to one or both of the switch ports.

In the basic configuration, one of the Gigabit ports can drive a VoIP phone directly with PoE and the other Gigabit port can be connected to a user's PC.

No external power supplies are required.

Technical Features

Power

- Fully compliant to IEEE 802.3af/at standard
- 1 Power Device (PD) input port 802.3af or 802.3at
- 2 Power Source Equipment (PSE) output ports 802.3af or 802.3at (dependent on PD input)

Data

- All ports are 10/100/1000Mbps (10BASE-T, 100BASE-TX, 1000BASE-T) auto sensing based upon the port's individual connection
- Each port has auto MDI-X
- 802.11q VLAN tagging
- Automatic address learning, address aging and address migration
- Supports 9216-byte jumbo frame length

Notification

- Link/Status and connection speed LEDs

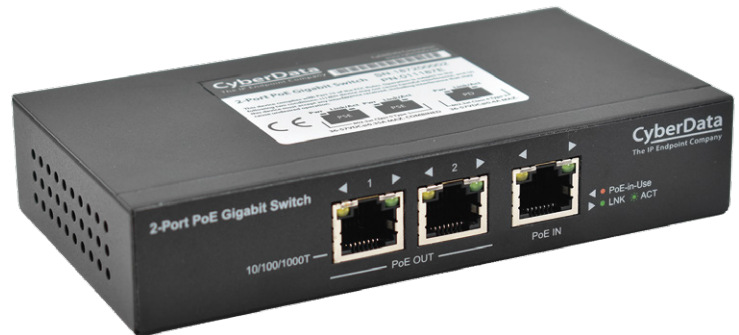

Specifications

Ethernet I/F 10/100/1000 Mbps, Auto MDI-X, RJ45

Power Distribution

Input	PD input up to 30W: <ul style="list-style-type: none">• 802.3af @ 15W• 802.3at @ 25W• Generic PoE Injector up to 30W
Internal Circuit Use	2W
Output*	Power available to share between two PSE outputs: <ul style="list-style-type: none">• 13W with 802.3af input• 23W with 802.3at input• 28W with generic 30W PoE injector input

Operating Range Temperature: -40° C to 55° C (-40° F to 131° F)
Humidity: 5-95%, non-condensing

Storage Temperature Temperature: -40° C to 70° C (-40° F to 158° F)
Storage Altitude Up to 15,000 ft. (4573 m)

Dimensions** 5.51 inches [140.0 millimeters] Length
3.03 inches [77.0 millimeters] Width
1.09 inches [27.7 millimeters] Height

Weight 0.55 lbs [0.25 kg]

Boxed Weight 0.82 lbs [0.37 kg]

Compliance CE: EMC Directive – Class A EN 55032, EN 55035 & EN-61000, Safety Directive EN 62368-1; RoHS Compliant; FCC Part 15 Class A; IEEE 802.3 Compliant

Warranty 5 Years Limited

Part Number 011187

* Either one or both of the PSE outputs can provide PoE power as long as the overall PSE output wattage is 2W less than the PD input.

**Dimensions are measured from the perspective of the product being upright with the front of the product facing you.

2-Port PoE Gigabit Switch

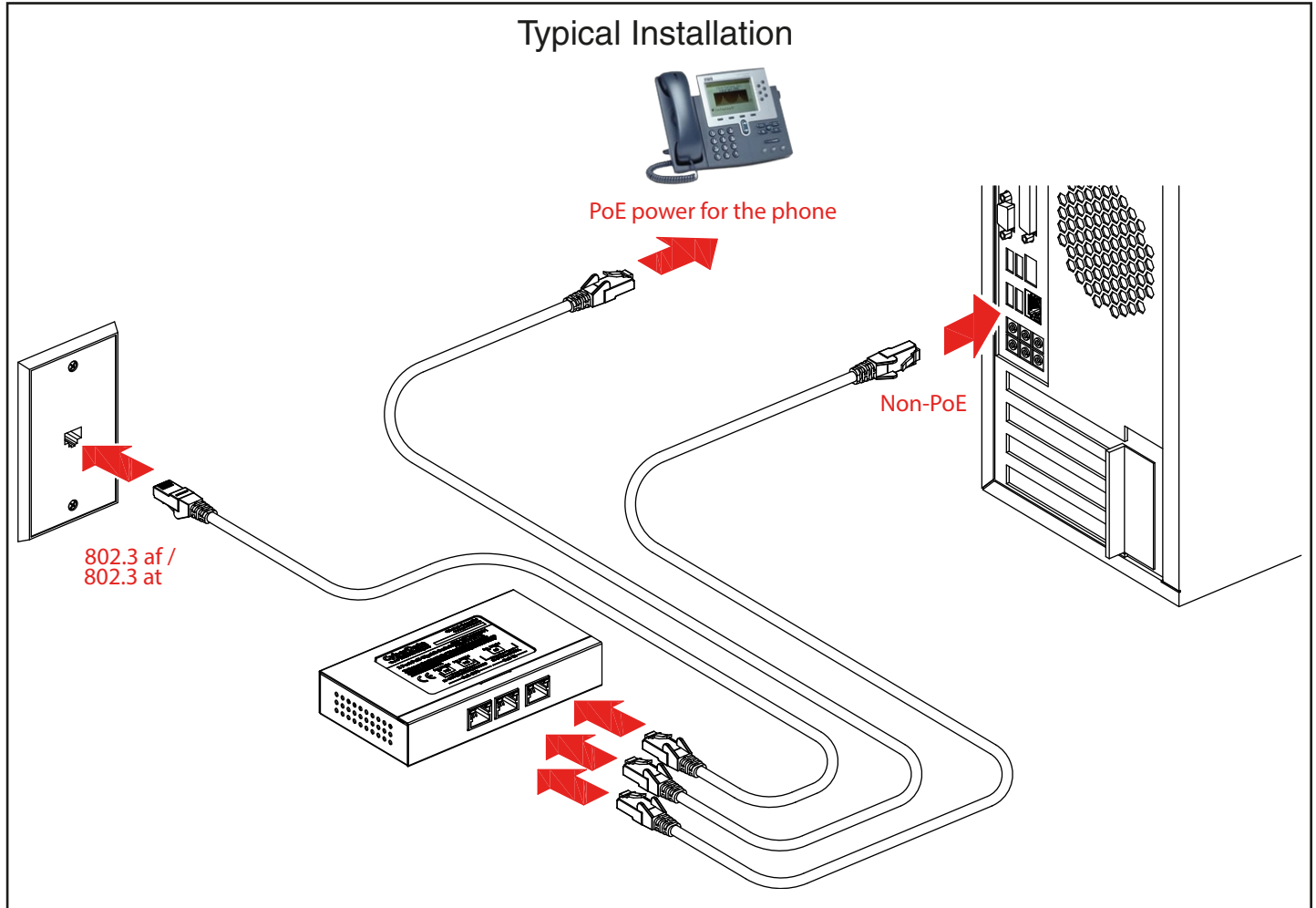

Screw* Mounting

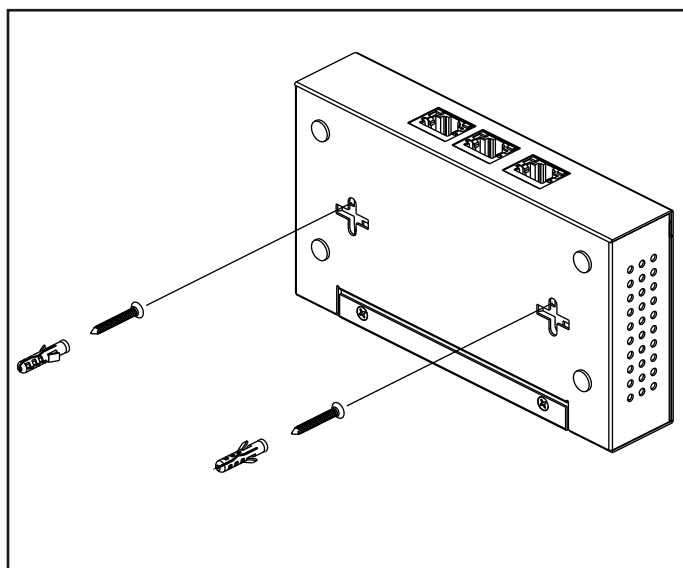

Adhesive* Mounting

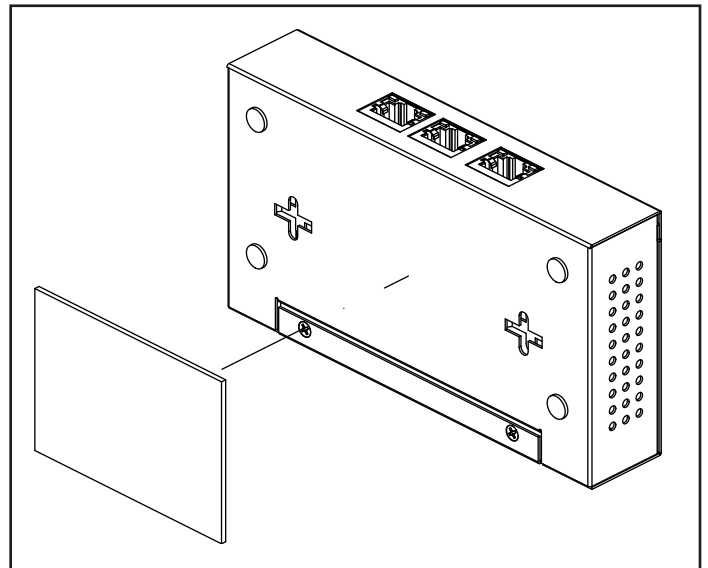

* Mounting screws and adhesive are included