



# DECT W620P (W710D+W620D) User Manual

Version: 1.0.0 | Date: 2026/04/13

## Directory

---

<b>Directory</b> .....	<b>2</b>
<b>1 Safety Instructions</b> .....	<b>8</b>
1.1 Safety Instructions .....	8
1.2 Battery Warning .....	9
<b>2 Overview</b> .....	<b>10</b>
2.1 Summary .....	10
2.2 Specification Introduction .....	10
2.2.1 W710D Specification Introduction .....	10
2.2.2 W620D Specification Introduction .....	11
<b>3 Installation</b> .....	<b>12</b>
3.1 Packing Contents .....	12
3.1.1 W710D Packing Contents .....	12
3.1.2 W620D Packing Contents .....	12
3.2 Install W710D .....	13
3.3 Install W620D .....	14
3.3.1 Installing the Battery .....	14
3.3.2 Battery Replacement .....	15
3.3.3 Connect the Charging Base .....	17
3.3.4 Installing Belt Clip .....	17
<b>4 Introduction to the User</b> .....	<b>18</b>
4.1 Instruction of Keypad .....	18
4.1.1 Instruction of Keypad for W710D .....	18
4.1.2 Instruction of Keypad for W620D .....	19
4.2 W620D Power On/Off .....	21
4.3 Language Settings .....	22
4.4 Country/Region Settings .....	22
4.5 W620D Standby Interface .....	23
4.6 W620D Menu .....	24
4.7 Device Status .....	25

4.8 Access W710D Webpage .....	26
4.8.1 Get IP Address .....	26
4.8.2 Access Webpage .....	26
4.9 W710D SIP Setting .....	27
<b>5 Terminal Management .....</b>	<b>28</b>
5.1.1 W710D Select Country/Region .....	28
5.1.2 Set PIN Code for W710D .....	28
5.2 W620D Connection Network .....	28
5.2.1 Enable Registration Mode for W710D (Enable Authorized) .....	28
5.2.2 Terminal User Connection Device .....	29
5.2.3 Call the Extension Number .....	30
5.3 Terminal Management .....	30
5.4 W710D Configuration Management .....	31
<b>6 W620D Call Features .....</b>	<b>32</b>
6.1 Using Handset / Hands-free Speaker / Headset .....	32
6.2 Initiate a Call .....	32
6.2.1 Initiate a Call .....	32
6.2.2 Call through Function Keys .....	33
6.2.3 Emergency Call .....	33
6.2.4 Redial .....	34
6.2.5 Callback .....	35
6.2.6 Anonymous Call .....	35
6.2.7 Hotline .....	36
6.3 Answer Incoming Calls .....	36
6.3.1 Manual Answering .....	36
6.3.2 Auto Answer .....	36
6.4 Reject Incoming Calls .....	37
6.4.1 Manual Rejection .....	37
6.4.2 Ban Anonymous Call .....	37
6.4.3 DND .....	37
6.5 End Call .....	38

6.6 Dial Query .....	38
6.7 Mute .....	38
6.7.1 Mute the call .....	38
6.7.2 Ringing Mute .....	39
6.8 Call Hold/Resume .....	39
6.9 Call Forwarding .....	39
6.10 Call Transfer .....	40
6.10.1 Blind Transfer .....	40
6.10.2 Semi-Attended Transfer .....	41
6.10.3 Attended Transfer .....	41
6.11 Call Waiting .....	41
6.12 Conference .....	42
6.12.1 Local Conference .....	42
6.12.2 Network Conference .....	42
<b>7 W620D Advanced Call Feature .....</b>	<b>44</b>
7.1 Call Park .....	44
7.2 Intercom .....	45
7.2.1 Make Intercom Call .....	45
7.2.2 Answer Intercom Call .....	46
7.3 Message .....	46
7.3.1 SMS .....	46
7.3.2 Voice Mail .....	47
<b>8 Phonebook .....</b>	<b>49</b>
8.1 Local Phonebook .....	49
8.1.1 Managing Local Phonebook Using the W710D .....	49
8.1.2 W620D Add / Edit / Delete Contacts .....	49
8.1.3 W620D Add / Edit / Delete Groups .....	50
8.1.4 W620D View / Add / Delete Contacts .....	50
8.2 Cloud Contacts .....	50
8.2.1 Configure Cloud Contacts .....	51
8.2.2 Download Cloud Phone Book .....	51

8.3 LDAP Contacts .....	51
8.3.1 Configure an LDAP Phone Book.....	51
8.3.2 Download the LDAP Phone Book.....	52
8.4 Blocked List.....	52
8.5 Allowed List.....	52
<b>9 Call History .....</b>	<b>53</b>
<b>10 Advanced Features .....</b>	<b>54</b>
10.1 Time Plan.....	54
10.1.1 W710D Time Plan.....	54
10.1.2 W620D Time Plan.....	55
10.2 Action Plan.....	55
10.3 Maintenance.....	56
10.3.1 W710D Configuration File.....	56
10.3.2 Upgrade.....	57
10.3.3 Auto Provision.....	63
<b>11 W620D Preference Settings .....</b>	<b>66</b>
11.1 Time Setting.....	66
11.2 Screen Setting.....	67
11.2.1 Backlight.....	67
11.2.2 Screensaver.....	67
11.2.3 Sleep.....	67
11.3 Audio Setting.....	68
11.3.1 Ringing Tone.....	68
11.3.2 Voice Volume Setting.....	68
11.3.3 Alert Info Setting.....	68
11.3.4 Tone Settings.....	69
11.3.5 Noise Reduction.....	69
11.4 Greeting Words settings.....	70
<b>12 Function Keys .....</b>	<b>71</b>
<b>13 W710D Network Settings .....</b>	<b>75</b>
13.1 Ethernet Settings.....	75

13.2 Network Mode .....	76
13.3 Web Server Type Settings .....	76
13.4 VPN .....	77
13.5 VLAN .....	78
<b>14 W620D Connecting Peripherals .....</b>	<b>80</b>
14.1 USB Flash Drive .....	80
14.2 Wired Headset .....	80
14.3 Bluetooth Headset .....	80
<b>15 Security .....</b>	<b>81</b>
15.1 W620D Menu Password .....	81
15.2 W710D Webpage Password .....	81
15.3 W620D Keyboard Password .....	81
15.4 W710D Web Filter .....	82
15.5 W710D Mutual Authentication .....	83
15.6 W710D Firewall .....	84
<b>16 Troubleshooting .....</b>	<b>86</b>
16.1 Obtain System Information .....	86
16.1.1 Obtain Information for W710D .....	86
16.1.2 Obtain system information for W620D .....	86
16.2 W620D Power On / Off .....	87
16.3 Reboot .....	87
16.4 Reset Device to Factory Default .....	87
16.5 Screenshot .....	88
16.6 Network Packets Capture .....	88
16.7 Get Log Information .....	89
16.8 W620D USB/USB Drive Upgrade .....	90
16.9 Common Trouble Cases .....	90
<b>17 Appendix .....</b>	<b>92</b>
17.1 Appendix I - W620D Key Icons .....	92
17.2 Appendix II - W620D Status and Notification Icons .....	92
17.3 Appendix III - W620D LED State Definition .....	94

17.4 Appendix IV - W620D Menu Icons ..... 94

17.5 Appendix V - W620D Keyboard Character Query Table ..... 95

17.6 Appendix VI - W710D LED Status Definition ..... 97

# 1 Safety Instructions

---

## 1.1 Safety Instructions

Please read the following safety notices before installing or using this unit. They are crucial for the safe and reliable operation of the device.

- Please use the external power supply that is included in the package. Other power supply may cause damage to the device and affect the behavior or induce noise.
- Before using the external power supply in the package, please check the home power voltage. Inaccurate power voltage may cause fire and damage.
- Please do not damage the power cord. If power cord or plug is impaired, do not use it because it may cause fire or electric shock.
- Do not drop, knock or shake the device. Rough handling can break internal circuit boards.
- This phone is designed for indoor use. Do not install the device in places where there is direct sunlight. Also do not put the device on carpets or cushions. It may cause fire or breakdown.
- Avoid exposure the device to high temperature or below 0°C or high humidity.
- Avoid wetting the unit with any liquid.
- Do not attempt to open it. Non-expert handling of the device could damage it. Consult your authorized dealer for help, or else it may cause fire, electric shock and breakdown.
- Do not use harsh chemicals, cleaning solvents, or strong detergents to clean it. Wipe it with a soft cloth that has been slightly dampened in a mild soap and water solution.
- When lightning, do not touch power plug, it may cause an electric shock.
- Do not install this phone in an ill-ventilated place. You are in a situation that could cause bodily injury. Before you work on any equipment, be aware of the hazards involved with electrical circuitry and be familiar with standard practices for preventing accidents.

## 1.2 Battery Warning

- To prevent the battery pack from leaking, overheating and catching fire. Please observe the following precautions:
- Soft aluminum packaging foil is easily damaged by sharp edged parts such as nickel sheets, pins and needles.
- Do not hit the battery pack with any sharp parts.
- Do not immerse the battery pack in water or seawater.
- Do not use and place the battery pack near heat sources such as fire or heaters.
- Do not reverse the positive and negative poles.
- Do not connect the battery pack to the power outlet.
- Do not throw the battery pack into fire or heat.
- Do not connect the positive and negative poles directly to metal objects such as wires, which may cause a short circuit of the battery pack.
- Do not transport and store batteries together with metal items such as necklaces and hairpins.
- Do not knock or throw the battery pack.
- Do not directly solder the battery pack or battery, and do not pierce the battery with nails or other sharp objects.
- Please use the charger configured at the time of purchase when charging.

## 2 Overview

### 2.1 Summary

DECT (Digital Enhanced Cordless Telecommunications) is a communication system based on DECT technology, which realizes reliable and high-quality wireless IP calls.

The DECT system Fanvil W620P is a Single-cell System, which consists of Base (W710D) and Handset (W620D).

The DECT Single Cell does not support roaming and only includes two roles: Base and Terminal. In the Fanvil W620P system, W710D is both the Base and the Manager of the system.

In the Fanvil DECT W620P System, a DECT Base can support up to 10 Handsets.

For users, the DECT system is a cost-effective wireless office system, which provides convenient operation while realizing environmental protection. A framework for cordless communication that provides high-quality voice and data services for high user density, small range communications.

### 2.2 Specification Introduction

#### 2.2.1 W710D Specification Introduction

Model	Fanvil W710D
Number of Handset	10
Concurrent Calls	10
Signal Range	Indoor: 50m Outdoor: 300 m
SIP Account	20
SIP Server	20
Internal Extension	10

Call History	20000
Frequency band	1880~1900MHz (European/South Africa) ,default item 1920~1930 MHz (America/Canada) 1893~1906 MHz (Japan) 1880~1895 MHz (Taiwan,China) 1910~1920 MHz (Brazil) 1786~1792 MHz (South Korea) 1910~1930 MHz (Latin America) 1909~1929 MHz (Argentina)
Status indicator light	3
Keys	Reset key x1
IPv6	√
DC Input	5V 1A
Ethernet Port	2 x 10/100M
PoE	√

## 2.2.2 W620D Specification Introduction

Model	W620D
Screen	240 * 320 color screen
SIP Line	4
Internal Extension	1
Local Contacts	1000
Call logs	600
Virtual Dsskey	8x2=16
Talk Duration	13h
Standby Duration	240h

### 3 Installation

#### 3.1 Packing Contents

##### 3.1.1 W710D Packing Contents

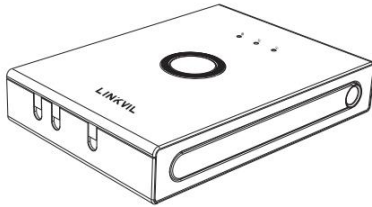

Base Station



PA3 \* 8mm screw \*

1



PA4 \* 30mm screw \*

2



Screw fixing seat \* 2

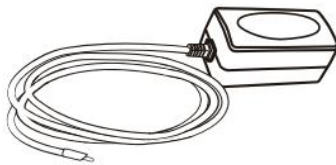

Power Adapter (optional)

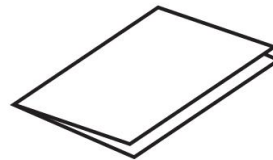

Quick Installation Manual

##### 3.1.2 W620D Packing Contents



Phone

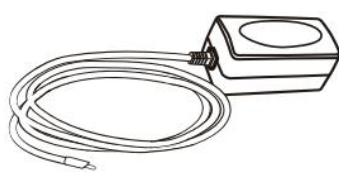

Power Adapter

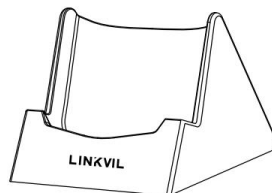

Charging Base

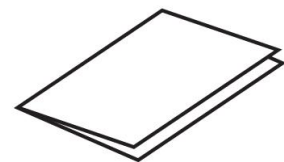

Quick Start Guide



Rechargeable Battery

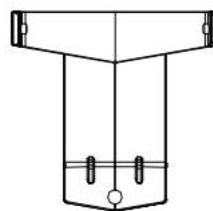

Belt Clip

## 3.2 Install W710D

### Step 1: Prepare before installation

#### 1. Voltage check

Check whether the voltage of DC power supply or external power supply is within the working range of this product (5V/1A).

#### 2. Adjust the antenna (Figure 1)

Press the heads of the antennas at both ends of the device (marked with red lines) with slightly, the antennas will automatically pop out, and then rotate the two antennas clockwise to the desired angle (the maximum rotatable angle is 190°).

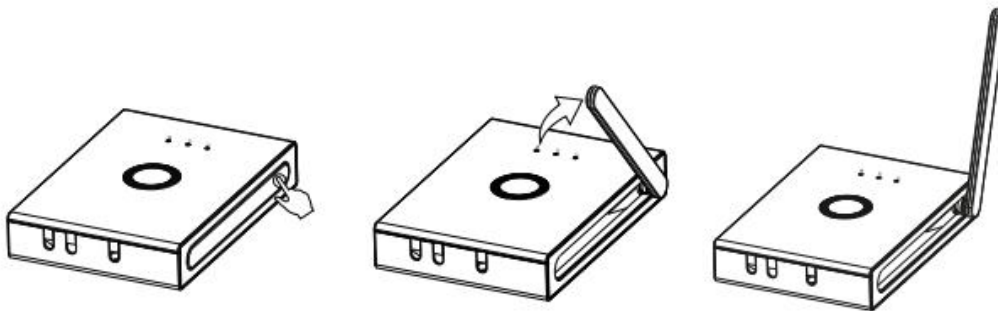

#### 3. Open the back cover (Figure 2)

Follow the arrows to slide down to open the back cover.

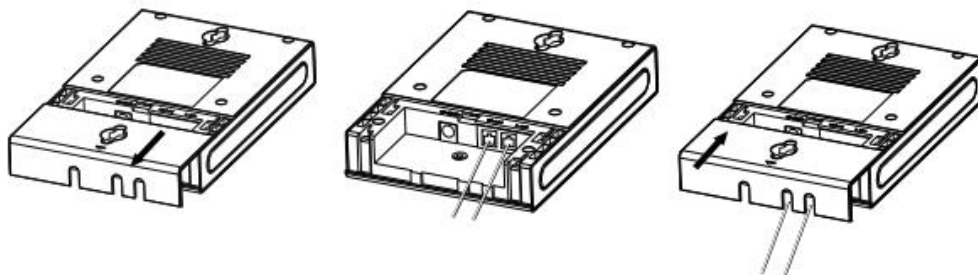

### Step 2: Connect your device, please follow the steps below:

1. Insert the ethernet cable into the WAN port of the device and connect the other end of the ethernet cable to an uplink port (a router or a modem, etc.)
2. Insert the power adapter into the device and connect it to a wall outlet.
3. The WAN LED will be solidly lit when the device and network is ready for use.

### Step 3: Wall installation

1. Close the back cover of the device after plugging in the cable, and punch the PA3\*8mm Screw into the hole in the back cover (Figure 3).

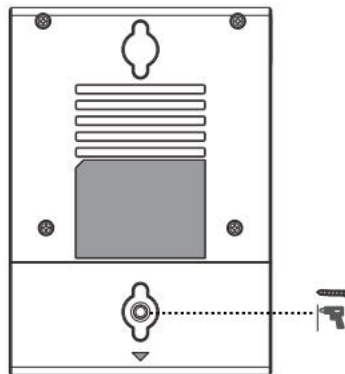

2. Wall mounting can be achieved by hanging the equipment on a screw suitable for the size and distance of the two holes above and below the back shell.

### 3.3 Install W620D

#### 3.3.1 Installing the Battery

1. Remove the rear case: Remove the rear case of the whole machine with a little force from the handle position A of the rear case of the main unit.
2. Install the battery: Take out the battery from the packaging box, with the battery with the notch facing up, put the battery at the battery compartment.
3. Install the back cover: Align the back cover with the buckle on the back of the main unit, press your hands along the edge of the main unit from top to bottom (there will be a "click" sound during the process), and ensure that there is no gap, it means that the back cover is fastened.

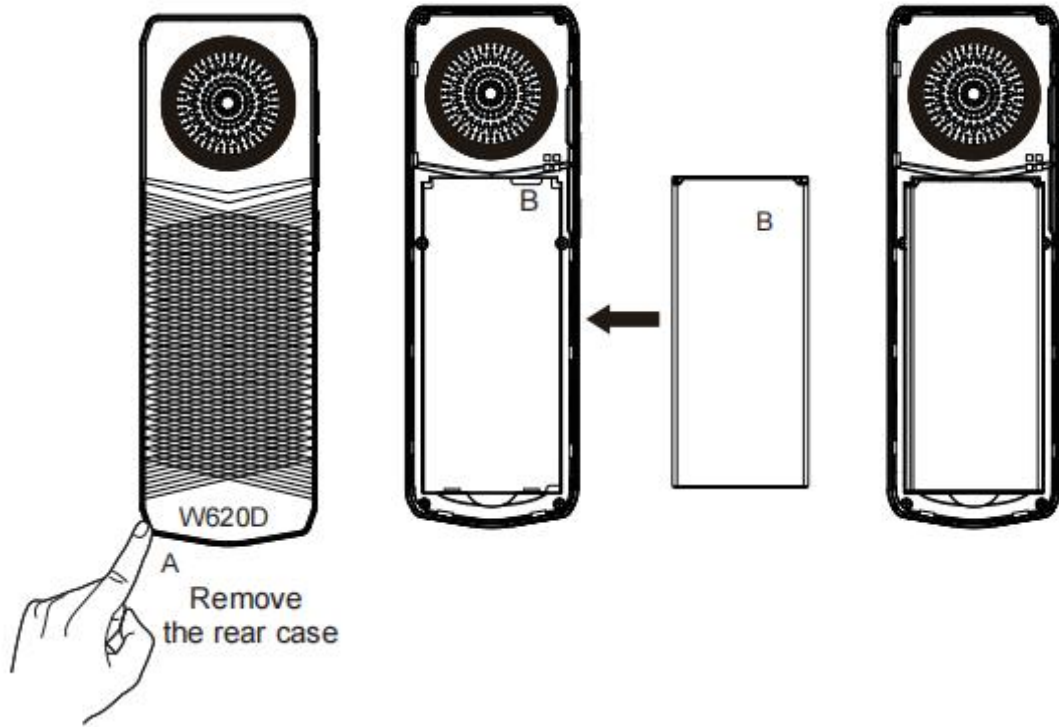

Removing the rear case

Installing the battery

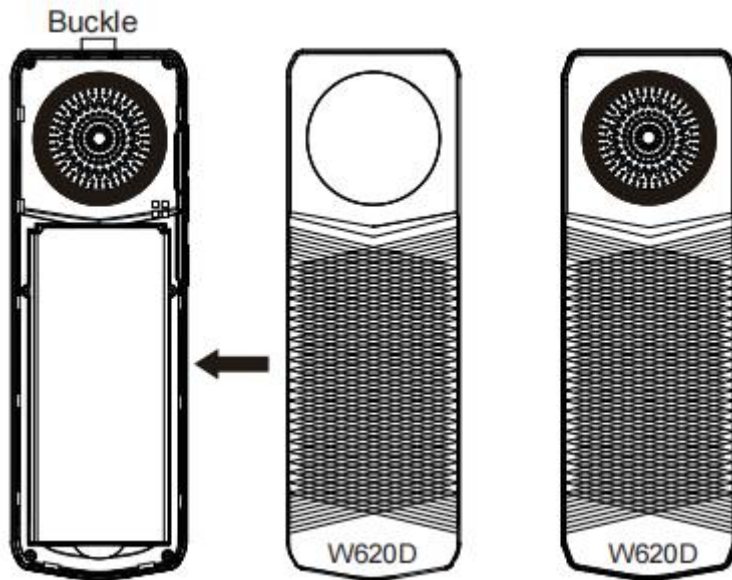

Installing the rear case

### 3.3.2 Battery Replacement

1. Remove the rear case: Remove the rear case of the whole machine with a little force from the handle position A of the rear case of the main unit.
2. Remove the old battery: Push up at B to remove the old battery.

3. Install the new battery: Take out the battery from the packaging box, with the battery with the notch facing up, put the battery at the battery compartment.
4. Install the back cover: Align the back cover with the buckle on the back of the main unit, press your hands along the edge of the main unit from top to bottom (there will be a "click" sound during the process), and ensure that there is no gap, it means that the back cover is fastened.

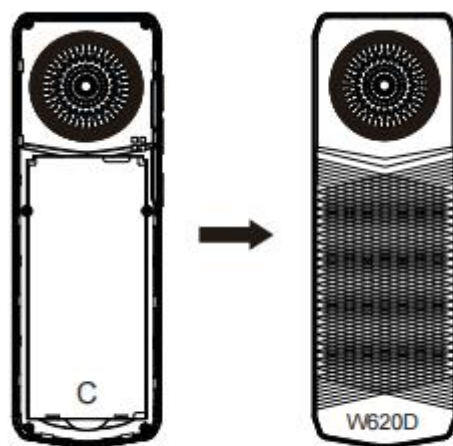
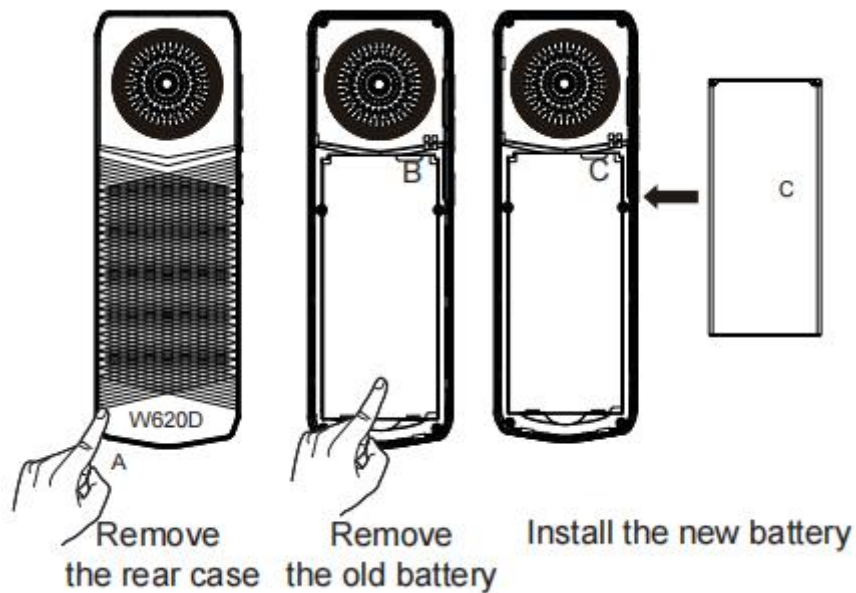

Install the back cover

### 3.3.3 Connect the Charging Base

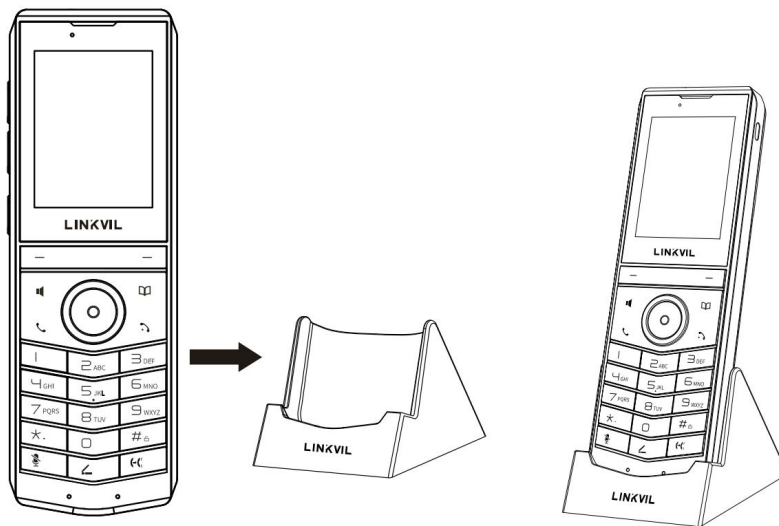

**!** **Note:**

- Please use the power adapter provided by Fanvil (5V/2A). A third-party power adapter may damage the handset.
- Check the charging status in the top-right corner of the LCD screen.

### 3.3.4 Installing Belt Clip

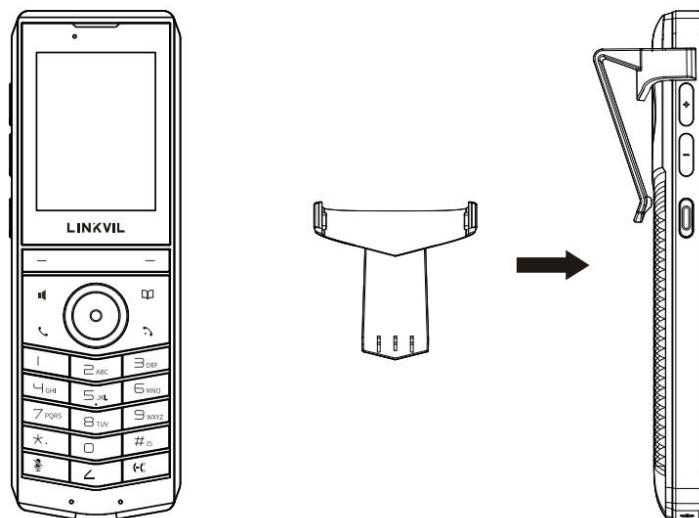

## 4 Introduction to the User

### 4.1 Instruction of Keypad

#### 4.1.1 Instruction of Keypad for W710D

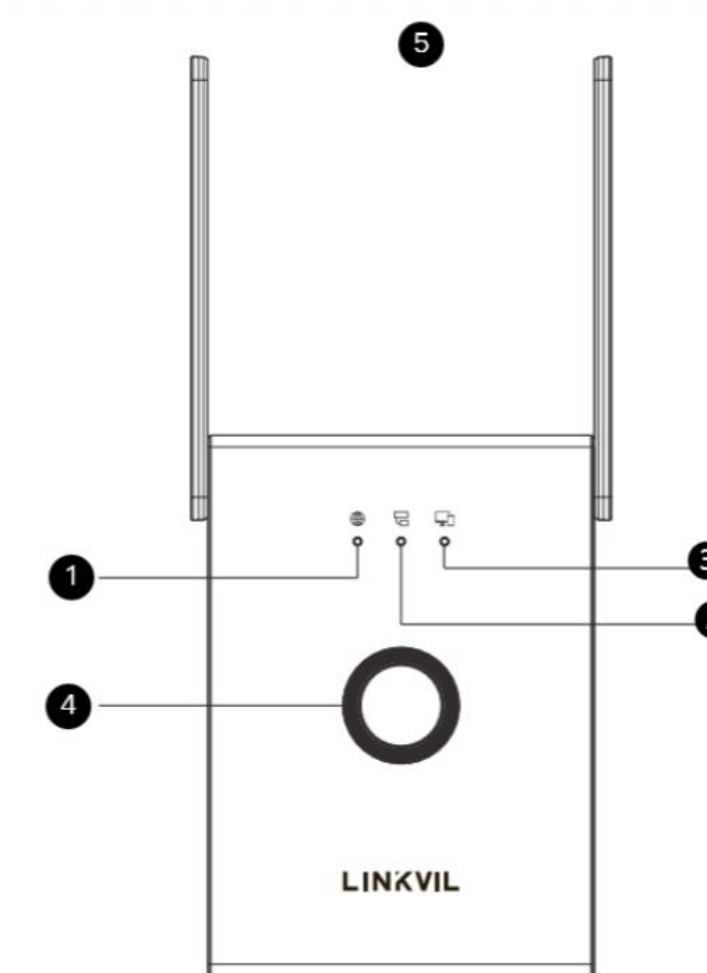

index	name	Description
①	WAN LED	<p>Indicates the WAN connection status.</p> <ul style="list-style-type: none"> <li>● On: Successfully connected to the local area network</li> <li>● Off: No network cable inserted</li> <li>● Flash: Network abnormality, such as IP conflict or inability to obtain IP</li> </ul>
②	ROLE LED	<p>Indicates the working role of the device.</p> <ul style="list-style-type: none"> <li>● On: The device works as a Manager</li> </ul>

		Note: In the Single-cell system, the W710D is both the Manager and the Base, and the ROLE LED is always on.
③	DECT LED	Flash: There is a active call in the system
④	Reset key	Long press the reset button 3S to enable Auto Authorized for fast pairing; Long press the reset button 10S to restore the device to its factory settings.

### 4.1.2 Instruction of Keypad for W620D

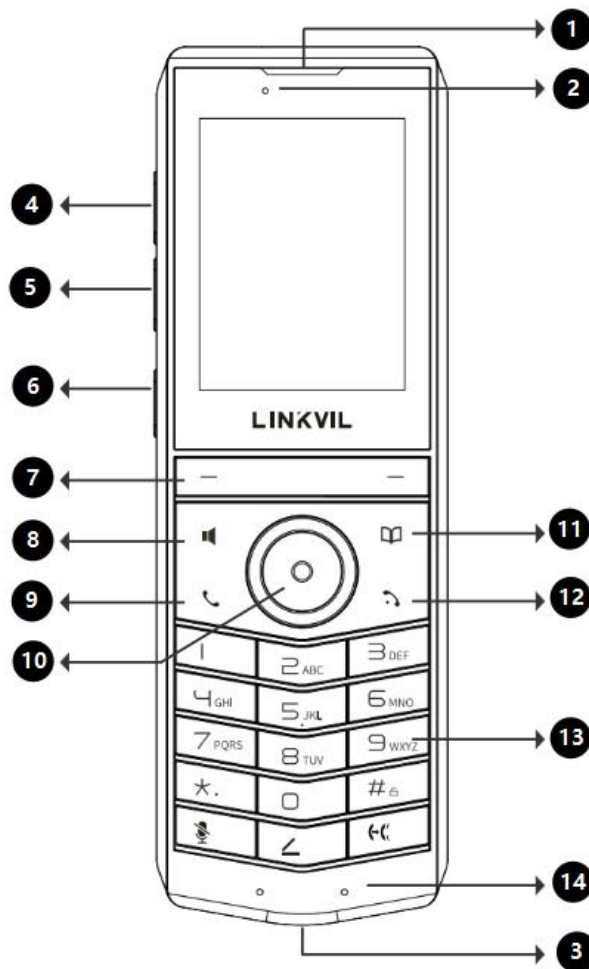

Index	Key Name	Description
①	Earpiece	Play sound when talking in handset mode.
②	Status indicator light	Indicates the status of the device during calls and charging.

③	Headset jack/Charging port	Insert headsets and open the headset channel.
④	Volume Key +	In standby mode, on the ringing and ringing configuration interface, press this key to increase the volume of the ringtone; On the call or volume adjustment interface, press this key to increase the volume.
⑤	Volume Key -	In standby mode, on the ringing and ringing configuration interface, press this key to reduce the volume of the ringtone; Press this key to decrease the volume on the call or tone/brightness adjustment interface.
⑥	Side Keys	Before configuration, short/long press to enter the function key setting interface and configure the required functions; After configuration, press to implement the corresponding function.
⑦	Function menu key	These three keys provide corresponding menu functions displayed on the screen
⑧	Handsfree key	Users can press this key to turn on the audio channel of the hands-free speaker.
⑨	Dial key	Dialing; Switch call channels.
⑩	Navigation key/ OK key	<p>Users can press the left/right navigation keys to change the route or move the cursor in the screen list.</p> <p>On some settings and text editing pages, users can press the left/right navigation keys to change options or move the cursor left/right in the screen list.</p> <p>OK key: It is equivalent to the confirmation software key by default, and users can customize the function.</p>
⑪	Phonebook key	By pressing the "Phone Book" key, users can enter the device book interface and select a contact person to make a call.



⑫	On-hook key	Return to the homepage; Hang up the call; Entering sleep mode; Exit sleep mode. Long press to power on/off.
⑬	DTMF Key	These 12 standard keys provide standard device key functions. At the same time, long pressing certain keys can trigger the provision of special functions. Press and hold the key # to lock the device (enable keyboard lock configuration). Long press the * key on the standby interface to mute the incoming call ringtone; Long press the * key on the call interface to mute the call.
⑭	Microphone	Receiving audio during calls

## 4.2 W620D Power On/Off

### Boot up operation

- Long press the red on-hook key  until it boots up.
- Connect the charging base and it will automatically boot up.

### Shutdown operation

- Soft shutdown: Long press the red on-hook key  to pop up a shutdown window and select whether to shut down.
- Hard shutdown: Press and hold the red on-hook key  until it shuts down.
- Automatic shutdown when low battery: When the battery is about to run out, it prompts "Low battery". The device automatically shuts down when the battery is depleted.

### Reboot

- Go to [Menu] by press OK key>> [Basic]>> [Reboot System], and select OK to confirm reboot.

## 4.3 Language Settings

Users can set the language of W620D through the device interface, and set the language of W710D through the web interface.

### **Set language under factory settings for W620D**

After startup under factory settings, the device will pop up a language selection box. After selecting the corresponding language, the user can click [OK] to confirm, or click [Back] to select the default language (default is English).

### **Set language when standby for W620D**

Set the language during standby, go to [Menu] by press OK key>> [Basic]>> [Language].

### **W710D web page setting language**

Log in to the W710D device webpage and set the language in the dropdown box in the upper right corner of the page

## 4.4 Country/Region Settings

Different regions have different frequency bands for DECT. In order to ensure the normal use of the DECT system, users need to select the country of W710D and W620D respectively.

### **Set Country/Region under factory settings for W620D**

After the device is started under factory Settings and the language is selected, the device pops up the Country/Region selection box. After the user selects the corresponding Country/Region and clicks "OK", the device automatically reboot. After reboot, the selected country/region is used.

### **Set Country/Region when standby for W620D**

Set the country/region when standby, go to [Menu] by press OK key >> [Network] >> [Country/Region].

### **W710D Web page Set Country/Region**

Visits the webpage>>Network>>Connection Settings>>Connection Settings, selects the corresponding country or region where the device is located, and sets different operating frequency bands..

**Note:**  
 Different countries/regions have different frequency bands, and users must select the corresponding country/region in order for the device to operate normally.

### 4.5 W620D Standby Interface

- The left figure shows the default interface when the gamepad is not connected to the Base. The figure on the right below shows the default standby screen interface after connecting Base, which is the status of the user interface most of the time.
- Users can restore the device to the default standby screen interface by pressing the on-hook key.
- The icon description is provided in [16.1 Appendix I](#).

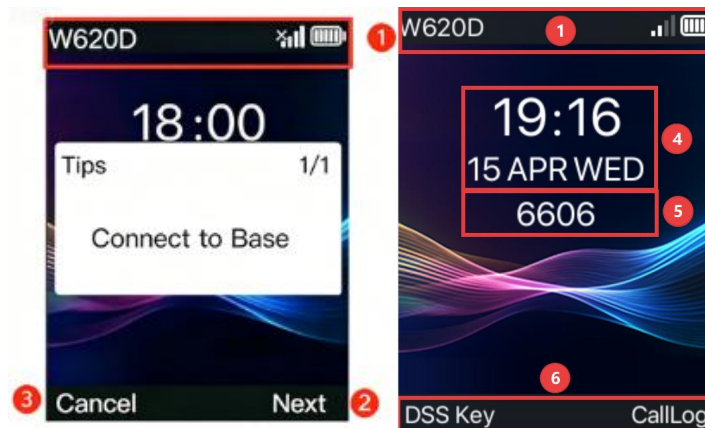

Index	Description
①	The main screen status bar displays the status and information of the device, such as network connection status, battery level, voice mails, missed calls, auto answer, do not disturb, locked status, etc.
②③	Click Softkey-Next to scan the Base and click Cancel to cancel the scan.

④	Display of time and date.
⑤	The registration status of the account
⑥	Function menu keys, which are also the first layer of function menu keys, allow users to operate the device through the keys

1. In some screens, due to too many items or long text, the screen cannot be fully displayed. They will be combined into a list accompanied by scrolling icons. If the user sees a scrolling icon, they can use the up/down navigation keys to scroll through the list.

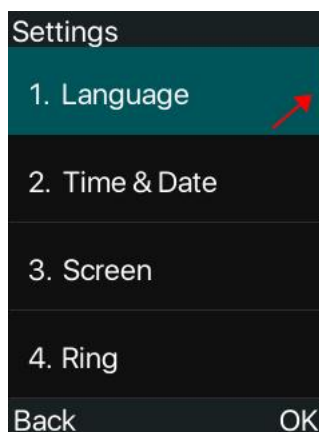

## 4.6 W620D Menu

In the standby interface, users can access the main menu by pressing the [OK] key; After entering the main menu, select the submenu application icon and click the [OK] key to access the submenu. The main menu displays as follows.



Index	Description
①	The status bar displays the currently selected menu item.
②	<p>Display the application icon for the menu item. The menu item list for W620D is as follows:</p> <p>Status: View the status of Manager, Network, Phone, and Account.</p> <p>Network: Connect to Manager/Base network.</p> <p>Basic: Set personal preference settings.</p> <p>Contact: Access all contacts.</p> <p>Message: View voice mails and SMS servers.</p> <p>Call Log: Access the call history list.</p> <p>Features: Set call forwarding, auto answer, call waiting, DND, intercom, ban anonymous calls, and other functions.</p> <p>Application: Set up memos and export logs through a USB drive, Set the Low Battery Tone.</p> <p>Advanced settings: Set keys, upgrade online, and Factory Reset.</p>
③	Softkey key

## 4.7 Device Status

Users can view the status of W620D through the device screen and view the status of W710D through webpage.

### View the status of W620D through the screen:

Access [Menu] by press OK key>> [Status] to obtain the following status information for W620D:

- Manager: displays the IP address, Firmware version, MAC address, RFPI and Country/Region(Frequency band) information of manager which the device connected.
- Network: displays the device's network Mode, network IP, RSSI(signal strength).
- Phone: Display device MAC address, Bluetooth MAC address, IPUI, Model, Hardware version, Software version, Uboot version, RAM, ROM, and Uptime information

of the device.

- Account: Display the name/number of the device's registered account and registration status information. Account 1-4 is the SIP Account, and account 5 is the internal extension number.

**View the status of W710D through webpage**

Refer to [4.8 W710D webpage management](#) login webpage, access the [System] >> [Information] page, and view the device status

- System Information: Display device Model, Hardware, Software, Uptime, Last Uptime, WAN Speed, MEMInfo, System Time, SN information.
- Network: Display device Network Mode, RFPI Code, MAC address, Ethernet IP, Subnet Mask, Default Gateway information.

## 4.8 Access W710D Webpage

### 4.8.1 Get IP Address

Users can obtain device IP through scanning tools:

1. The computer is connected to the same local area network as W710D, and Device Manager is installed on the PC

Device Manager: <https://www.fanvil.com/service/doc/soft/tools/tools/ipscanner/index.html>

2. Open the IP scanning tool (Device Manager) and click Rescan to obtain the IP of the W710D device in the local area network.

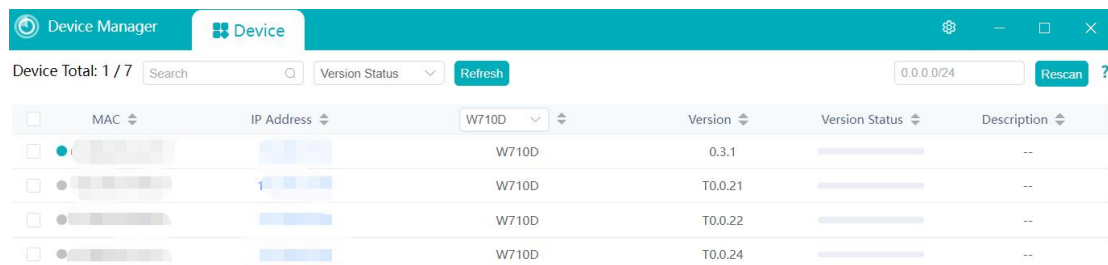

### 4.8.2 Access Webpage

Ensure that the computer and device are on the same LAN, open the browser, enter the obtained device IP, log in to the device webpage, and enter the login page.

Users must enter their username and password correctly in order to log in to the webpage. The default username and password are both "admin".

## 4.9 W710D SIP Setting

The terminal device W620D must have a line configured in order to perform call services. W620D can make calls using SIP accounts or internal extension numbers. The use of SIP accounts allows for communication with personnel outside the DECT system; Using an internal extension number can only communicate with terminal devices in the same DECT system.

To use a SIP account, it is necessary to set up information such as the SIP server and SIP account; By using an internal extension, there is no need to configure SIP server or other information. After the terminal device connects to Manager/Base, it automatically obtains the internal extension number.

**The SIP settings for W710D are carried out by the administrator of DECT system, and the steps for setting are as follows:**

### 1. Add SIP server

Visit the W710D Manager webpage>> [SIP Account] >> [SIP Server], click Edit to add a SIP server. Enter the corresponding information for the server address, domain name, and server port, which is provided by the SIP server administrator.

### 2. Add SIP account

- Manually add a single SIP account: Visit the W710D Manager webpage>> [SIP Account] >>[SIP Account] , click Add, select SIP Server and manually fill in the SIP account information:Authentication User, Authentication Password, User Number, Display Name(SIP Account Name), etc. These information are provided by the SIP server administrator.
- Batch import of SIP accounts: Visit the W710D Manager webpage>>[SIP Account]>>[SIP Account]s, click Export to export the template. After editing the template and adding a SIP account, click Import to import the list of SIP accounts. Note that the imported template must be UTF-8 encoded.

## 5 Terminal Management

---

### 5.1.1 W710D Select Country/Region

The administrator visits the webpage>>Network>>Connection Settings>>Connection Settings, selects the corresponding country or region where the device is located, and sets different operating frequency bands..

**Note:**

Different countries/regions have different frequency bands, and users must select the corresponding country/region in order for the device to operate normally.

### 5.1.2 Set PIN Code for W710D

**Set PIN code**

- The administrator visits the Manager webpage>>Network>>Connection Settings>>PIN Code Settings, enters the old password, and confirms the new password.

**Note:**

The default PIN code is: 1234

## 5.2 W620D Connection Network

To use the basic communication functions of the DECT system, it is necessary to first connect the terminal device W620D to Manager/Base W710D. The steps are as follows:

### 5.2.1 Enable Registration Mode for W710D (Enable Authorized)

There are three ways to enable Registration Mode (Enable Authorized) for W710D Manager.

#### 1. Fast Pairing (Enable Auto Authorized) with firmware 1.18.5 or later

Enter Registration Mode of W710D without login webpage.

- 1) Press and hold Reset key of W710D for 3S until ROLE & CALL LED fast flash twice. Release the key to enter Auto Authorized mode (ROLE LED on, CALL LED slow-flashing). It will be auto disabled after 90S.
- 2) You can also access the W710D webpage Handset>Maintenance>Settings, enable Auto Authorized and click Apply. It won't be auto disabled with this way.

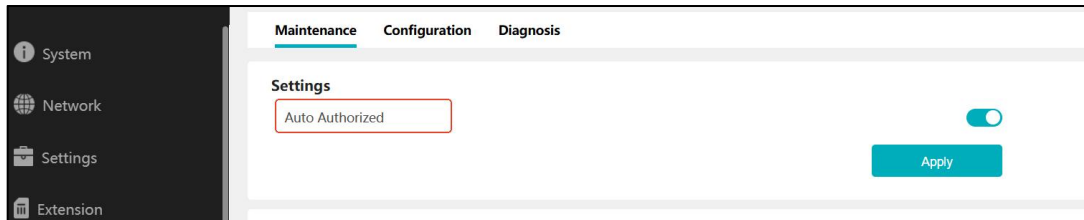

## 2. Add a single device manually

Add a single device manually: Access the W710D webpage>Handset >Maintenance, click Add, fill in the terminal IPUI, Name, select SIP account and internal extension number. Note: Only when Authorized To Access is enabled can the terminal access the base network.

## 3. Batch import of devices

Access the W710D Manager webpage>Handset >Maintenance, click Export, and export the template. After editing the template and adding devices, click Import to import the device list. Note that the template must be UTF-8 encoded.

### 5.2.2 Terminal User Connection Device

- Under factory settings, after the user starts the W620D device and manually selects the device language and country/region (which must be the same as the Manager), the device will reboot.
- After the device reboot, users can click Softkey-Next or go to enter [Menu] by press OK key>> [Network]>> [Available Networks], select the Manager's RFPI code, click Link, and enter the PIN code (1234 by default) to successfully connect.
- After a successful connection, the terminal automatically obtains the configuration

(assigned SIP account and internal extension number) and can perform calls and other operations.

### 5.2.3 Call the Extension Number

You can call with the handsets in the system using extension without SIP server.

#### 1. Viewing the Extension number

You can view the extension number on the Manager webpage and the LCD of handset.

##### 1) View the Extension List on the handset

- Press the physical phonebook key of the Handset and select Extension. The online handset's extension will be displayed here. Users can view and make calls.

##### 2) View the Extension of yourself on the handset

- When there is no registered SIP Account, the standby screen will display the extension number.
- When a SIP number is registered, you can go to the Menu > Status > Account, and the 5th line will display the Extension number.

##### 3) View on the Manager side

- Access the W710D webpage > Handset > Maintenance, and view the Extension number in the Extension column.

#### 2. Make call using Internal Extension

The way using Handset A calls Handset B:

- Enter B's 4-digit extension number on Handset A, click Dial to make the call.
- Press the physical phonebook key of the Handset A and select Extension of B,click Dial to make the call.

## 5.3 Terminal Management

After W620D successfully connects to Manager/Base, the administrator can manage and operate information on the W620D terminal on the W710D Manager>>[Handset] page, including:

- **Terminal information viewing:**

- Administrators can view the online status, IPUI Code, internal extension number, SIP account, name, model, software version number, and current connection Base of the terminal.
- **SIP account management:**
  - Administrators can perform operations such as adding, deleting, and editing SIP accounts on the terminal. Please refer to [4.9 SIP Settings](#) for specific steps.
- **Operation:**
  - Administrators can perform operations such as Editing/ Deleting/ DND/ Rebooting/ Updating Configurations.
- **Contact management:** Distribute and delete local contacts/ cloud phone book contacts/ LDAP contacts, etc. for the terminal, please refer to [8 Phonebooks](#) for specific methods.
- **View history:** View and manage terminal call records on the Manager webpage. For specific methods, refer to [9 Call History](#).
- **Upgrade:** Upload the terminal firmware through Manager and upgrade it

## 5.4 W710D Configuration Management

- **Configure terminal configurations on W710D by administrator**
  1. Visit the W710D Manager webpage>> [Handset]>> Configuration, add configuration files, and set configuration file names.
  2. Click the edit button to access the created configuration file, select the desired configuration to make changes.
  3. Visit the W710D Manager webpage>> [Handset]>> [Maintenance], select the device, edit, configure the file, select the file name from the previous step, and click OK.
  4. Visit the W710D Manager webpage>>[Handset]>>[Maintenance], select the device, click Update Config to update the corresponding terminal device configuration.

## 6 W620D Call Features

---

### 6.1 Using Handset / Hands-free Speaker / Headset

- **Using of Handset**

Regarding the use of the handset: Users can press the green dial key to enter the number, then press the dial key or "#" key; Or enter the number first and then press the dialing key, the number will be dialed out. When the speaker is turned on, users can switch device audio channels by pressing the green dial key.

- **Using Hands-free Speaker**

Regarding the use of the hands-free speaker: Users can first press the hands-free key  to dial the number, or dial the number first and then press the hands-free key. When the voice channel of the handset is open, users can switch the device's audio channel by pressing the hands-free speaker key.

- **Using Headset**

Regarding the use of headsets: In the default state, the headset channel is turned on by default after inserting the headsets. When the headsets are inserted, users can enter the number by pressing the dial key, then press the dial key or "#" key; Alternatively, by entering the number first and then pressing the dial key, the number will be dialed out and a call can be established through the headset channel. When the speaker is turned on, users can switch device audio channels by pressing the dial key.

### 6.2 Initiate a Call

#### 6.2.1 Initiate a Call

##### Dialing method

- **Open the dial to make a call:** Use the hands-free key/handset key to open the dial, enter the number, press the Hands-free key/dial key/Softkey-Dial/"#" key to make a call.
- **Pre dial dialing:** Enter the number directly, press the Hands-free key/dial key/Softkey-Dial/"#" key to make a call.

- **Calling through a phone book:** Access [Menu] by press OK key>> [Contact], or press the devicebook key to access the Local Contacts/Cloud Contacts/LDAP phonebook, select a contact, press Softkey-Option>> Dial /Hands-free key/Dial key, and call out the selected contact number.
- **Calling through call log:** Access [Menu] by press OK key>> [CallLog], or Softkey - CallLog, select a call log, press Softkey-Option>> Dial /Hands-free key/Dial key, and call out the selected number.
- **Making a second call:** During the call, users can access the [More]>> [New Call]/[Transfer]/[Meeting] keys to make a second call; You can also dial out through the BLF number or Speed Dial function set by the function keys.

#### Switch line dialing:

- Open the dial using the hands-free/dial keys, or enter the number directly and switch to the line using the navigation key- Left/Right key.

## 6.2.2 Call through Function Keys

#### Configure function keys on terminal devices

- In standby mode, press Softkey - Dsskey/Navigation key - Left/Navigation key - Right, or the Side Key on the device right to select the function key for editing.
- After the key of Softkey-Dsskey is edited, the user can edit it by select it and long press the OK-key.

#### Calling through function keys

- In standby mode, access the list of dsskeys through Softkey - Dsskey/Navigation key - Left/Navigation key - Right, select function keys, and press the hands-free/dial keys to call out.
- Press the Side Key on the device right side in standby mode to call out.

## 6.2.3 Emergency Call

The emergency call function is used to enable the keyboard lock, and users can set the corresponding emergency call number on the device. When the device is locked, emergency services can also be called.

The usage steps are as follows:

1. Configure emergency call numbers through the W710D Manager by the administrator: Follow the steps in section [5.4 W710D Configuration Management](#), access the created configuration file>> [Settings]>> [Feature Settings], and set Emergency Call Number. If you need to set multiple Emergency Call Number, please use "," to separate them.
2. After setting the keyboard lock on the device, you can call the emergency call number without unlocking it.

## 6.2.4 Redial

Users can use the redial button to redial the last dialed number. The steps for redialing are as follows:

### 1. Set redial button

Users can set the PTT button, function key, or Softkey on the side as the redial key.

Setting method:

- **Set by administrator through W710D Manager**
  - According to the steps in [5.4 W710D Configuration Management](#), access the created configuration file>>[Function Key], configure the DSSKEY button, PTT button, and Softkey button as function keys - Redial. Update the configuration to the device.
- **Configure function keys on terminal devices**

Users can set the Side Key, function key, or Softkey on the side as the redial key.

Setting method:

  - In standby mode, press the Softkey - dsskey/navigation key - left/navigation key - right, or the Side Key on the device right, select the function key for editing, and set the Keyevent - redial.

### 2. Redial operation

- **Redial the last outgoing number:**

When the device opens the dial/standby, press the redial key, and the device will call out the last dialed number.
- **Use the redial key to call any number:**

Enter the number on the device, press the redial key, and the device will call out the

entered number.

### 6.2.5 Callback

Users can use the callback button to call out the last miss incoming call number (if there is no call record, press the callback button and the device will prompt "Cannot process").

The callback steps are as follows:

1. Set up callback settings

- **Set by administrator through W710D Manager**

- According to the steps in section [5.4 W710D Configuration Management](#), access the created configuration file>>[Function Key], and configure the DSSKEY button, PTT button, and Softkey button as the function key - callback. Update the configuration to the device.

- **Configure function keys on terminal devices**

- In standby mode, press the Softkey - Dsskey/navigation key - left/navigation key - right, or the Side Key on the device right, select the function key for editing, and set the Keyevent - Callback.

2. When the device opens the dial/standby, press the callback key, and the device will call out the number of the last miss incoming call.

### 6.2.6 Anonymous Call

The device can set up anonymous calls to hide the calling number and name. After enable anonymous call, the call name displayed on the other end is anonymous.

- Anonymous calls are set up by administrators through W710D Manager:

1. Visit the Manager webpage>>[SIP Account]>>[SIP Account], select a SIP account, click the edit button, and access the Advanced Settings module>>Anonymous Call Standards.

2. The default value is Disabled, which means it is in the off state. There are two optional parameters, RFC3323 and RFC3325.

3. Choose any one to enable anonymous calls for this SIP account.

## 6.2.7 Hotline

After setting up hotline dialing, the device will automatically call according to the hotline delay time by pressing the green dialing key, hands-free key, and other methods to open the dial.

- Set up hotline dialing by administrator through W710D Manager:
  1. Visit the Manager webpage>>[SIP Account]>>[SIP Account], select a SIP account, click the edit button, and access the Basic Settings module>>Enable Hotline.
  2. Turn on the hotline, set the hotline number, and set the hotline delay time.

## 6.3 Answer Incoming Calls

### 6.3.1 Manual Answering

- **Idle state with incoming calls:** Users can answer calls by pressing the Softkey - Answer, dial key , or hands-free key to open the headset/handset/hands-free channel.
- **Answer the second incoming call:** When there is another incoming call during the call, the device will play a call waiting tone in the voice channel of the current call, and the LED indicator light will flash orange quickly. Users can press the Softkey key - Answer; You can also locate the second incoming call through the navigation keys, and answer the call by pressing the Softkey - Answer, dial key, or hands-free keys to open the headset/handset/hands-free channel.

### 6.3.2 Auto Answer

After enabling the Auto Answer function, the device can automatically answer to incoming calls. Auto Answer can be enabled by distinguishing lines.

It can be set by the administrator on the Manager webpage, or the user can activate the Auto Answer function on the terminal. After enabling auto answer, an icon  is displayed in the upper right corner of the screen.

- **Set by administrator through W710D Manager**
  - Visit the Manager webpage>>[SIP Account]>>[SIP Account], select a SIP

account, click the edit button, access the Basic Settings module>>Enable Auto Answer, set the waiting time for Auto Answer, and submit.

- **Configure on terminal devices**

- Access [Menu] by press OK key>> [Feature]>> [Auto Answer], press the key to select the line, use the left/right navigation keys to enable/disable the auto answer, set the Auto Answer Delay, and press the [OK] key to save after completion.

## 6.4 Reject Incoming Calls

### 6.4.1 Manual Rejection

When receiving a call, you can manually reject it by pressing the Softkey - Reject or on-hook key . Rejected calls will be displayed in the missed call list in the history list.

### 6.4.2 Ban Anonymous Call

After enabling ban anonymous calls, the device will automatically reject anonymous calls and will not ring. It can be set by the administrator on the Manager webpage or launched by the user on the terminal.

- **Set by administrator through W710D Manager**

- Visit the Manager webpage>>[SIP Account]>>[SIP Account], select a SIP account, click the edit button, and access the Advanced Settings module>>Turn on [Ban Anonymous Calls] .

- **Configure on terminal devices**

- Access [Menu] by press OK key>> [Features]>> [Ban Anonymous Call], press the key to select the line, use the left/right navigation keys to enable/disable the option of ban anonymous calls, and press the [OK] key to save after completion.

### 6.4.3 DND

Users can enable the DND feature on their device to reject incoming calls (including call waiting). It can be set by the administrator on the Manager webpage or launched by the user on the terminal.

- **Set by administrator through W710D Manager**

- Access the Manager webpage>>[Handset]>>[Maintenance], select an online device, click the DND button to enable/disable the device's DND.

- **Configure on terminal devices**

- Access [Menu] by press OK key>> [Features]>> [DND], enable dnd mode through the left/right navigation keys, and press the [OK] key to save after completion.

## 6.5 End Call

After the user's call ends, they can press the Softkey - End key or on-hook key to end the call.

## 6.6 Dial Query

The device defaults to enabling dial query function. Enter two or more digits of the number, and the dialing interface will automatically match the call history and contact number list. Use the up and down navigation keys to select the number, press the dial key, or call out after timeout.

## 6.7 Mute

Users can enable mute mode during a call, turn off the device's microphone, and prevent the other party from hearing local sound. Under normal circumstances, the mute mode automatically turns off as the call ends. You can also enable the mute function on the standby page to automatically mute the ringtone when an incoming call occurs.

Mute mode can be activated in all call modes (headset, handset, or hands-free).

### 6.7.1 Mute the call

Users can mute during calls by long pressing the \* key, or mute/unmute using the Softkey key.

- After muting during a call, the call interface displays a mute icon . Muting method during calls:

1. Press the [More]>> [Mute] key during the call.
2. Long press the \* key during a call.

#### 1. Unmute call:

1. Press "More">"Unmute" again on the device to unmute, and the mute icon will no longer be displayed on the call interface.
2. Or long press \* again to unmute the call.

### 6.7.2 Ringing Mute

Users can mute the ringing sound by long pressing the \* key, or enable/disable the mute sound by using the volume up/down key. After mute for incoming calls, the device displays a ringtone mute icon in the upper right corner. When there is an incoming call, the device displays the call interface but does not ring.

- Turn on ringtone muting
  - Press and hold the \* key during device standby to mute.
  - Press the volume down key to mute when the device is in standby mode.
- Unmute incoming call ringtone
  - Press and hold the \* key during device standby to unmute.
  - Press the volume up key to unmute the ringtone when the device is in standby mode.

After cancellation, the mute icon  will no longer be displayed in the upper right corner.

### 6.8 Call Hold/Resume

Users can press the Softkey - Hold key to hold the current call, and this key will become a resume key. Users can press the Softkey - Resume key to resume the call.

### 6.9 Call Forwarding

Call forwarding is the function of diverting incoming calls to other numbers. User can configure the call forward settings of each line.

There are three types of call forwarding:

- **Call Forward Unconditional:** Forward all incoming calls to the configured number.
- **Call Forward on Busy:** When the user is busy and call waiting is disabled,

incoming calls will be forwarded to the configured number.

- **Call Forward on No Answer:** When user does not answer the incoming call after the configured delay time, the incoming call will be forwarded to the configured number.

Call forwarding can be set by the administrator on the Manager webpage, or by the user on the terminal.

- **Set by administrator through W710D Manager**
  - Visit the Manager webpage>>[SIP Account]>>[SIP Account]>>[Basic settings], set the forwarding type, number, and time.
- **Configure on terminal devices**
  - Access [Menu] by press OK key>> [Features]>> [Call Forwarding], select the line by the up/down navigation keys, click OK, select the call forwarding type through the up/down navigation keys, click OK, and configure the enable/disable and delay time of call forwarding.

## 6.10 Call Transfer

When the user is talking with a remote party and wish to transfer the call to another remote party, there are three way to transfer the call, Blind transfer, Attended transfer and Semi-Attended transfer.

- **Blind transfer:** No need to negotiate with the other side, directly transfer the call to the other side.
- **Semi-Attended transfer:** When you hear the ring back, transfer the call to the other party.
- **Attended transfer:** When the caller answers the call, transfer the call to the other party.

### 6.10.1 Blind Transfer

During the call, the user presses the function menu key [More]>> [Transfer], enters the number to be transferred, or presses the contact key or history key to select the number. Press the transfer key again to blindly switch to a third party. After the third party rings, the device displays "Transferring"; After the third-party answers, the device shows

successful transfer and hangs up.

### 6.10.2 Semi-Attended Transfer

During the call, the user presses the [Transfer] key on the function menu, enters the number to be transferred, or presses the contact key or history key to select the number. When the call key is pressed, and the third party is not answering, the user presses the transfer key on the call interface to perform Semi-Attended transfer or press the end key to cancel Semi-Attended transfer.

### 6.10.3 Attended Transfer

Attending transfer is also known as the " courtesy mode ", which involves calling the other party and waiting for them to answer the call before transferring the call.

Calling is also the same process. In dual call mode, press the [Transfer] key to transfer the first call to the second call.

## 6.11 Call Waiting

After enabling the call waiting function, users can accept new incoming calls during the call process; After turning off the call waiting function, new incoming calls will be automatically rejected and a busy tone will be displayed.

When the call waiting prompt is enabled, the device will play a beep tone when a new call is received during the call.

Call waiting can be set by the administrator on the Manager webpage, or by the user on the terminal.

- **Set by administrator through W710D Manager**
  - According to the steps in [5.4 W710D Configuration Management](#), access the created configuration file>>[Actions]>>[Feature Settings], enable/disable [Enable Call Waiting], and click submit to save. Update the configuration to the device.
- **Configure on terminal devices**
  - Access [Menu] by press OK key>> [Features]>> [Call Waiting]>> [Call Waiting Settings], use the left/right navigation keys to enable/disable call waiting and call

waiting tone.

## 6.12 Conference

The device supports creating local and network conference. The conference mode is set by the administrator through the W710D Manager. The setting method is as follows:

- Access the Manager webpage>> [SIP Account]>> [SIP Account]>> [Basic Settings]>and set the conference mode.

### 6.12.1 Local Conference

Users need to set the conference mode to local for local conference.W620D support 6 ways local conference.

#### Two methods for creating local conference

- The device already has two calls. Press the [More]>> [Conference] key on the call interface, select the conference number through the navigation up and down keys, and press the [OK] key to establish a local conference.
- There is a one way call on the device. Press the conference key on the call interface, enter the number you want to join the conference, and press the dial key; After receiving the call from the other end, press the conference key again to establish a local conference.

### 6.12.2 Network Conference

The user needs support from the SIP server for network conference. Please confirm with the administrator.

#### How to join a network conference

- Multiple party call network conference room number, enter password to enter all conference rooms.
- Two devices have established a regular call. Press the conference key to invite new members to the conference, and follow the voice prompts to proceed.

**Note:**

- Network conferencing requires server support. Please confirm with the administrator whether the account supports network conference.
- The methods and steps for participating in network conferences on different servers may vary. Please confirm the specific steps with your administrator.
- The maximum number of attendees for server conference varies depending on the server.

## 7 W620D Advanced Call Feature

---

### 7.1 Call Park

Users can suspend a call during a call and then retrieve the call on this or other devices.

**Note:**

- The call park function requires support from the server. Please confirm with the administrator.
- The call park or retrieve methods of different servers may vary. Please confirm with your administrator.

#### Set function keys

To use the call dwell function, it is necessary to set the function key to the Call Park button in advance. The function key can be set through the terminal device or configured through the W710D webpage management function key.

- **Configure function keys by administrator in W710D Manager**

According to the steps in section [5.4 W710D Configuration Management](#), access the created configuration file>>[Function Keys], configure the DSSKEY or Side Keys, with the key type being Memory Key - Call Park, set the key values and save them, assign the configuration to the corresponding device and update it.

- **Configure function keys on terminal devices**

In standby mode, press the Softkey - Dsskey/navigation key - left/navigation key - right, or the Side Key on the device right, select the function key for editing, set the function key type to Memory Key - Call Park to set the key value and save it.

#### Call park/ retrieve through function keys

- During a call, press the Call Park function key to pause the call.
- When idle, you can press the corresponding function key on this device or other devices to retrieve calls.

## 7.2 Intercom

After enabling the intercom function, the device can auto answer incoming calls in intercom mode.

### 7.2.1 Make Intercom Call

#### 7.2.1.1 Regular intercom

To use the intercom function, it is necessary to set the function key to the Memory - Intercom key in advance.

The function key can be set through the terminal device or configured through the W710D webpage management function key.

- **Configure function keys by administrator in W710D Manager**
  - According to the steps in section [5.4 W710D Configuration Management](#), access the created configuration file>>[Function Keys], configure the DSSKEY or Side Keys, with the key type being Memory Key - Intercom, set the key values and save them, assign the configuration to the corresponding device and update it.
- **Set intercom function keys**
  - In standby mode, press Softkey - Dsskey/navigation key - left/navigation key - right, or the Side Key on the device right, select the function key for editing, set the function key type to Memory Key - Intercom, set the key value and save it.
- **Make intercom calls through function keys**
  - Press the intercom function key to make a intercom call.

#### 7.2.1.2 PTT Intercom

##### Set PTT intercom function key

To use the PTT intercom function, it is necessary to set the function key to PTT - intercom key in advance. The function key can be set through the terminal device or configured through the W710D webpage management function key.

- **Configure function keys by administrator in W710D Manager**
  - According to the steps in section [5.4 W710D Configuration Management](#),

access the created configuration file>>[Function Keys], configure the PTT button with the PTT intercom type, set the key value and save it, assign the configuration to the corresponding device and update it.

- **Set PTT intercom function key**
  - In standby mode, press the Side Key on the device right to edit, set the function key type to PTT intercom, set the key values and save them.
  
- **PTT intercom call through function keys**
  - In standby mode, press and hold the Side Key to initiate a intercom call.
  - Release the key to end the call.

## 7.2.2 Answer Intercom Call

After enabling the intercom mode, the device can auto answer incoming calls in intercom mode.

### 1. Enable intercom on terminal devices

Access [Menu] by press OK key>> [Features]>> [Intercom] to enable/disable intercom.

The explanation of the intercom configuration Parameters is as follows:

Item	Description
Intercom	When the Intercom is enabled, the device will auto answer the incoming call with the SIP header Call-Info command.
Intercom Mute	Enable mute function during intercom mode calls.
Intercom Tone	The device plays an announcement when receiving an incoming call in intercom mode.
Intercom Barge	Enable the Intercom Barge, when the device is in calls and receives a new intercom call, it auto answers the call.

## 7.3 Message

### 7.3.1 SMS

If the service of the SIP account supports the SMS function, when the other party sends

~~a SMS to this number, the user will receive a notification of the SMS and display a new SMS icon on the standby screen interface.~~ If your SIP account supports SMS, you will receive notifications of the SMS and display a new SMS icon on the standby screen interface.

- **Send SMS**

1. Visit [Menu] by press OK key>> [Message]>> [SMS], create a new message, select the route and the number to send it to
2. After editing, click send to proceed

- **View SMS**

1. Access [Menu] by press OK key>> [Message]>> [SMS], select [Inbox], and enter the SMS inbox interface
2. Select the unread message and press the [OK] key to read it

- **Reply to SMS**

1. Access [Menu] by press OK key>> [Message]>> [SMS], select [Inbox], and enter the SMS inbox interface
2. Select the message you want to reply to, select [Option]>> [Reply], edit it, and click send to proceed

### 7.3.2 Voice Mail

If the server of this line supports voice mail function, the calling party can keep the voice mail to the server when the user does not respond. The user will receive a notification of the server's voice mail and a new voice mail icon will be displayed on the standby screen interface.

To listen to voice mails, users must first configure a voice mailbox number. After configuring the voice mailbox number, users can retrieve voice mails for the default SIP line.

#### Steps for listening to voice mails:

- Select [Menu] by press OK key>> [Message]>> [Voice Mail]

- Select [OK] to open the voice mail configuration interface, and select the desired route by pressing the up/down navigation keys.
- Press the [Edit] key to edit the number for the voice mail. Once completed, press the [OK] key to save the configuration.
- SIP1 (m/n) Line: "m" before parentheses represents unread voice mails, and "n" represents the total number of voice mails.
- Call the voice mail number, enter the PIN code according to the prompt tone, and listen to the voice mail.

## 8 Phonebook

---

### 8.1 Local Phonebook

Users can save contact information in their phone book and directly dial the contact's phone number in the device book. Users can open their phone book by pressing [Menu] by press OK key>[Contact] or the preset key on the device [Contact].

By default, the device book is empty, and users can manually add or add contacts to the device book from their call history (or cloud phone book).

The contacts will be sorted alphabetically. Users can browse by pressing the up/down navigation keys. The current record indicator tells the user the specific location of the currently located contact. Users can view contact information by pressing the [OK] key.

#### 8.1.1 Managing Local Phonebook Using the W710D

Access the W710D Manager webpage >> [Phonebook] >> [Local Contacts] page, in the Local Contact list, select online devices, select Import/Export/Clear contacts:

- Import: Import local contacts with csv/xml format to the selected device. You can export contacts file first, edit file according to the exported template, and then import it.
- Export: Exports the local contacts of the selected device.
- Clear: Clears local contacts of the selected device.

Note:

- 1) Devices that are not online on this page cannot be selected.
- 2) Currently, only one device can be selected at a time.

#### 8.1.2 W620D Add / Edit / Delete Contacts

To add a contact, the user needs to enter the contact group and press the "Add" button to open the interface for adding a contact.

- Name
- Office number

- Mobile
- Other Number
- Line
- Ring type
- Group

Users can edit contacts by pressing the [Option]>> [Edit] key.

To delete a contact, the user should first move the indicator to the contact they want to delete, press the [Option]>> [Delete] key, and confirm by pressing [OK].

### 8.1.3 W620D Add / Edit / Delete Groups

By default, the group list is empty. Users can create their own groups, edit group names, add or remove contacts from groups, and delete groups.

- Add Group: Access [Menu] by press OK key >> [Contact] >> [Local Contacts], and press the [Add] key, edit the Name and Ring Type.
- Delete the group: Select the group, press the [Option]>> [Delete] key, and press [OK] to confirm.
- Edit the group: Press the [Option]>> [Edit] key.

The total number of contacts in this group is indicated in parentheses.

### 8.1.4 W620D View / Add / Delete Contacts

Open the group list, and users can view the contacts in the group by pressing the [OK] key.

When viewing contacts in a group, users can enter the add contact interface by pressing the [Option]>> [Add] key, and then click [OK] to save the contact. This contact will also be synchronized and saved to the [local contacts]>> [All Contacts]. You can also delete contacts in the group through [Option]>> [Delete].

## 8.2 Cloud Contacts

Cloud phone book allows users to download phone books from cloud servers to their devices. This is very convenient for office users to use the device book. The phone book

can be downloaded from the cloud phone book server with just one click, making it very convenient for creating and maintaining contact lists.

**Note:**

Cloud phone was originally designed to ensure that its content is the latest version, and each time it is opened, it only temporarily downloads its contacts to the device. However, downloading may take a few seconds depending on the network connection quality during device use. Therefore, in order to save waiting time for downloading, it is recommended that users save important contact information from the cloud phone book to the local location.

## 8.2.1 Configure Cloud Contacts

### Configure cloud phone book by administrator in W710D Manager

Visit the Manager webpage>>[Phonebook]>>[Cloud Phonebook], configure the name, URL, username, and password of the cloud phone book. After configuration is completed, when the handset connects to the Manager/Base network, the contact person of the cloud phone book can be obtained.

## 8.2.2 Download Cloud Phone Book

To access the list of cloud phone books, access [Menu] by press OK key>>[Phonebook]>>[Cloud Phone Book] through W620D, where you can see the cloud phone books that you set up.

## 8.3 LDAP Contacts

### 8.3.1 Configure an LDAP Phone Book

#### Configure LDAP phone book by administrator in W710D Manager

Visit the Manager webpage>>[Phonebook]>>[Cloud Phonebook]>>[LDAP], configure the name, Server Address, Search Base, Username, and Password of the LDAP phone book. After configuration is completed, when the handset connects to the Manager/Base network, the contact of the LDAP phone book can be obtained.

### 8.3.2 Download the LDAP Phone Book

After the administrator has configured the LDAP phone book, the user can access the list of cloud phone books through W620D and access [Menu] by press OK key>> [Contacts]>> [Cloud Contacts], where you can see the LDAP phone book configured.

## 8.4 Blocked List

The device supports block lists. If a number is added to the Blocked List, the incoming call from that number will be directly rejected by the other end, and the local device will display missed calls. (Prevent the number in the call list from being called out normally)

- There are multiple ways to add a device to the Blocked List, which can be directly added in [Menu] by press OK key>> [Contacts]>> [Blocked List].
- Select any number in the device book (both local and network) to add.
- Select any number in the call history to add.

## 8.5 Allowed List

The device supports the allowed list, such as adding a number to the allowed list. Even when DND/forwarding is enabled, the device can still receive calls from that number (numbers outside the allowed list will be automatically rejected/forwarded, etc.).

- You can directly add allowed list in [Menu] by press OK key>> [Contacts]>> [Allowed List], set the number/prefix, and the type of allowed call.
- Select any number in the device book (both local and network) for configuration and addition.
- Select any number in the call history to configure and add.

## 9 Call History

---

### Viewing call logs on the device

- **View call logs:** The phone can store call logs (the number of stored calls varies depending on the specifications). Users can click [Menu] by press OK key>> [Call Log]>> [Local Call Log] to open call logs and view all incoming, outgoing, forwarded and missed call logs.

In the call history screen interface, users can browse call logs by pressing the up/down navigation keys.

- **Delete call logs:** Users can delete call logs by pressing the [Option]>> [Delete] key, or [Option]>> [Delete All] to delete all call logs.
- **Add to Phone Book:** Each call record will display "Call Type", "Caller Number/Name", and "Call Time". Users can further check the details of call logs by pressing the [OK] key and dial by pressing the [Dial] key, or add numbers from call logs to the device book by pressing [Option]>> [Add to Contacts].

### Administrators view call logs through Manager

- Visit the Manager webpage>>[Call Logs]>>[Call Logs], view and search for call records of all devices, and export and clear call records.
- Visit the Manager webpage>>[Call Logs]>>[Call Record Statistics] to view the number of calls in the system, as well as the number of incoming calls, outgoing calls, missed calls, and forwarded calls.

**Note:**

Deleting and clearing call records in the Manager will not affect the display of call records on the device.

## 10 Advanced Features

### 10.1 Time Plan

Time Plan settings can be used to set a time point or a time period. A time point is when an action is executed at a certain moment, and a time period is when an action is executed at a certain time.

Administrators can manage the time plan of W710D or manage the time plan of terminals through W710D Manager.

#### 10.1.1 W710D Time Plan

- The time plan types supported by W710D include: Timed Reboot, Timed Upgrade, and Timed Config.
- The Repetition Period can be set to: No Repetition, Daily, Weekly, Monthly.
- The method of setting is:
  - Visit the Manager webpage>>[Actions]>>[Time Plan], set the Name, Type, and Repetition Period, as well as the Effective Date and Time, then click add. After the setup is completed, W710D will execute the corresponding action at the set time.

#### Configuration parameter description:

Item	Description
Name	The name of the custom time plan rule.
Type	Action types executed at time points/time periods: Timed Reboot, Timed Upgrade, Timed Config.
Date	When the repetition type is Daily/No Repetition, the value is empty.
Effective Time - Start Time	The start time when the rule takes effect.
Effective Time - End Time	The end time of the rule.

**Note:**

If there are calls during the set time period, it will skip the reboot/upgrade operation.

### 10.1.2 W620D Time Plan

- The time plan types supported by W620D include: Timed Reboot and Timed Forwarded.
- The repetition type can be set to: No Repetition, Daily, Weekly, Monthly.

Setting method:

- **Configure time plan by administrator in W710D Manager**

According to the steps in [5.4 W710D Configuration Management](#), access the created configuration file>>[Actions]>>[Time Plan], configure the name, action type, and repetition type, as well as the effective date and time, and click Add. After setting up, assign the configuration to the corresponding device and update it, and the corresponding terminal will execute the corresponding action at the set time.

## 10.2 Action Plan

Action Plan is a technology defined and designed by Fanvil for remote control and behavior linkage between Fanvil terminal devices and other devices. That is, when an event occurs on the Fanvil terminal, the terminal can execute an action that is completed according to a Plan rule.

Setting method:

- **Configure Action Plan for the terminal by the administrator through the Manager webpage**

According to the steps in [5.4 W710D Configuration Management](#), access the created configuration file>>[Line]>>[Action Plan] and configure the action plan rules. After setting up, assign the configuration to the corresponding device and update it, and the corresponding terminal will execute the corresponding action when the event occurs.

**Configuration parameter description:**

Item	Description
Action	<p>The action is when the rule for number configuration is triggered.</p> <p>The supported types are:</p> <p>Record: When the rule is triggered, the phone automatically activates the recording function.</p> <p>Mute: The phone automatically mutes when the rule is triggered.</p> <p>Answer: When the rule is triggered, the phone automatically answers incoming calls.</p>
Number	<p>The call number corresponding to each Action Plan; Supports the same number expression as Dial Plan</p>
Type	<p>The types of time periods triggered by rule execution, including:</p> <p>Early: Trigger execution before call establishment.</p> <p>Connected: Trigger execution after call establishment.</p>
Line	<p>The selected rule corresponds to the matching SIP line.</p>
Direction	<p>Behavior processing method for corresponding configuration rules:</p> <p>Both: trigger both incoming and outgoing calls simultaneously;</p> <p>Deactivation: Triggered upon outbound call:</p> <p>Incoming call: triggered when an internal call is received.</p>

## 10.3 Maintenance

### 10.3.1 W710D Configuration File

Users with administrator privileges can view, export, or import device configurations on the W710D webpage >>[System]>>[Configurations] page, and can also restore the device to its factory settings.

#### Import/Export Configurations

- Visit the W710D webpage >>[System]>>[Configurations]>>[Export Configurations], select the corresponding format, click download to export the configuration file in the corresponding format;

- Visit the W710D webpage>>[System]>>[Configurations]>>[Import Configurations], select the configuration file, click upload to import the configuration file. You can import configuration files in NC,XML, and TXT formats.

**Clear The Tables**

- Visit the W710D webpage>>[System]>>[Configurations]>>[Clear The Tables], select the database list, move to the clear list, and click clear to clear the selected data.

**Factory Reset**

- Visit the W710D webpage>>[System]>>[Configurations]>>[Reset Devices], and clear all device data, including configuration and database tables.

**10.3.2 Upgrade**

There are three upgrade methods for W710D:

- Web upgrade
- Online upgrade
- Auto Provision upgrade.

There are four ways to upgrade the W620D:

- Upgrade the handset through W710D:
  - Locally upload the firmware of W620D from the webpage of W710D(Only software versions is above 1.7.0 support)
  - Get the firmware of W620D from HTTP server.
- USB upgrade;
- Upgrade via USB flash drive



**Note:**

- During the process of uploading the version and upgrading the software, do not disconnect the power supply or network.
- The W620D will only be upgraded if it meets both charging and non-talking conditions.

- Due to the small DECT bandwidth and the large firmware size of the handset, the upgrade time of W620D through W710D takes about 3~5 hours.;The USB upgrade and USB flash drive upgrade take about 3 minutes.It can be selected according to different scenarios and requirements.
- W620D online upgrades use “xxx.z” software, USB upgrades and USB flash drive upgrades use “xxx.bin” files(note that they using different .bin file).

### 10.3.2.1 W710D Web Upgrade

#### W710D webpage upgrade

- Visit the W710D webpage>>[System]>>[Upgrade]>>[Software Upgrade], select the W710D software version, click Upload, and upgrade the W710D software.

### 10.3.2.2 W710D Online Upgrade

#### Configuration for online upgrade by administrator on W710D Manager webpage:

- Visit the W710D webpage>>[System]>>[Upgrade]>>[Online Upgrade] to configure the upgraded server and update cycle. Place the upgraded TXT file and software on the corresponding server. When the device detects that the software stored on the server does not match its own software version number, it will prompt for an upgrade.

#### Configuration parameter description:

Item	Description
<b>Upgrade server</b>	
Enable Auto Upgrade	Enable Auto Upgrade, If there is a new version txt and new software firmware on the server, phone will show a prompt upgrade message after Update Interval.
Upgrade Server Address1	Set available upgrade server address.
Upgrade Server Address2	Set back up available upgrade server address.
Update Interval	Set Update Interval. Enable Auto Upgrade and configure the Update Interval. If the server has a new firmware, the phone will prompt for upgrade at the interval.

Firmware Information	
Current Software Version	It will show Current Software Version.
Server Firmware Version	It will show Server Firmware Version.
[Upgrade] button	<p>If there is a new version txt and new software firmware on the server, the page will display version information and upgrade button will become available; Click [Upgrade] button to upgrade the new firmware.</p> <p>Note you can only upgrade the firmware for W710D using the button.</p>
New Firmware Information	When there is a corresponding TXT file and version on the server side, the TXT and version information will be displayed under the new version description information.

**Step instructions:**

1. After completing the configuration of the Manager webpage, place the version information TXT file in the configured HTTP server.

The naming format of the version information TXT file is vendor\_model\_hwv1,0.txt. The corresponding version information file names for W710D are as follows:

Model	Version information file name
W710D	fanvil_W710D_hwv1_0.txt

2. The TXT file format must be UTF-8, and the content format is:

```
Version=2.12.0 # Software version number
Firmware=http://ip:port/xxx.z #The URL of the software version file
BuildTime=2023.09.11 20:00
Info=TXT

Release Note:
Xxxxx
Xxxxx
Xxxxx
```

3. After the update interval is reached, if the server has available TXT files and version files, the W710D webpage displays the upgrade button available and the Release Note in the TXT file, which users can click to upgrade to the W710D version.

### 10.3.2.3 Upgrade the Handset through W710D

#### 10.3.2.3.1 Locally Upload the Firmware of W620D through W710D

- Visit Manager webpage >> [Handset] >> [Upgrade]>> [Local Software Upgrade], select the firmware of W620D, obtain or manually edit the software version number, click Apply.
- After apply, the firmware will display in the Firmware List([Handset] >> [Upgrade]>>Firmware List) .

#### Note

- The device can only recognize the software version number in the default firmware name, such as:  
 "W620D-linkvil-release-ff01-9005-1.16.4-krnvUT2024-11-06-16.20.27.z",  
 the version number is identified as "1.16.4" and filled into the software version number input box. If you manually change the name of the firmware file, please enter the correct version number.
- The submitted version number must be consistent with the uploaded firmware. If the handset detects that the version number is inconsistent, the firmware will be upgraded repeatedly.
- The Manager can store a maximum of one terminal firmware.

#### 10.3.2.3.2 Get the Firmware of W620D from HTTP Server.

#### Configuration for online upgrade by administrator on W710D Manager webpage:

- Visit the W710D webpage>>[Handset]>> [Upgrade]>>[Upgrade Server] to configure the upgraded server and update cycle. Place the upgraded TXT file and software on the corresponding server. When the device detects that the software stored on the

server does not match its own software version number, it will prompt for an upgrade.

**Configuration parameter description:**

Item	Description
<b>Upgrade server</b>	
Enable Auto Upgrade	Enable Auto Upgrade, If there is a new version txt and new software firmware on the server, phone will show a prompt upgrade message after Update Interval.
Upgrade Server Address1	Set available upgrade server address.
Upgrade Server Address2	Set back up available upgrade server address.
Update Interval	Set Update Interval. Enable Auto Upgrade and configure the Update Interval. If the server has a new firmware, the phone will prompt for upgrade at the interval.
<b>Firmware Information</b>	
Current Software Version	It will show Current Software Version.
Server Firmware Version	It will show Server Firmware Version.
[Upgrade] button	If there is a new version txt and new software firmware on the server, the page will display version information and upgrade button will become available; Click [Upgrade] button to upgrade the new firmware.  Note you can only upgrade the firmware for W710D using the button.
New Firmware Information	When there is a corresponding TXT file and version on the server side, the TXT and version information will be displayed under the new version description information.

**Step instructions:**

1. After completing the configuration of the Manager webpage, place the version information TXT file in the configured HTTP server.

The naming format of the version information TXT file is vendor\_model\_hwv1,0.txt. The corresponding version information file names for W620D are as follows:

Model	Version information file name
W620D	fanvil_W620D_hwv1_0.txt

2. The TXT file format must be UTF-8, and the content format is:

```
Version=2.12.0 # Software version number
Firmware=http://ip:port/xxx.z #The URL of the software version file
BuildTime=2023.09.11 20:00
Info=TXT

Release Note:
Xxxxx
Xxxxx
Xxxxx
```

3. After the update interval is reached, if the server has available TXT files and version files, W620D automatically detects the upgrade in the charging and non-call state.

### 10.3.2.4 W620D Upgrade and Upgrade Pause

1. When W710D detects that the version number in the TXT file is different from the current version number of the handset, it pushes a new software version to the handset. The new firmware will be automatically upgraded when the handset meets both of the following conditions,:

- The handset is in charging state
- The handset is not talking state

When the handset is in the upgrade state, the upgrade icon  is displayed on the standby status bar/screen saver screen. You can also view the upgrade status and progress from the handset Menu > Advanced > Upgrade.

2. When the handset is in the following state, the upgrade processing event is paused. After the event is over, the upgrade continues.

- Pause the upgrade when there is an incoming/outgoing call, or during call. The

upgrade will continue after end of call.

- When power is off/shut down/restarted, the upgrade is suspended; The upgrade will continue after the restart.
- When the network is disconnected (for example, outside the Base signal range), the upgrade is suspended; The upgrade will continue after the network is normal.

When the handset is in the paused upgrade state, the upgrade pause icon is displayed on the standby status bar or screen saver screen. You can also view the paused upgrade status and upgrade progress from the handset Menu > Advanced > Upgrade.

### 10.3.3 Auto Provision

**Administrators can auto provision W710D devices.**

1. Visit the W710D webpage>>[System]>>[Auto Provision] and configure the Auto Provision parameters.
2. The terminal supports four methods to obtain Auto Provision application parameters: SIP plug and play, DHCP parameter selection, static deployment of servers, and TR069. If these four methods are configured simultaneously, the device will be upgraded based on the method obtained first.
3. Transport protocol support: FTP, TFTP, HTTP, HTTPS.
4. This article only briefly introduces Auto Provision. For detailed instructions, please refer to the document Fanvil Auto Provision.

#### Configuration parameter description

Items	Description
<b>Basic settings</b>	
Authentication Name	The user name of provision server
Authentication Password	The password of provision server
Configuration File Encryption Key	If the device configuration file is encrypted , user should add the encryption key here
General Configuration File Encryption Key	If the common configuration file is encrypted, user should add the encryption key here

Download Fail Check Times	If there download is failed, phone will retry with the configured times.
Update Contact Interval	Phone will update the phonebook with the configured interval time. If it is 0, the feature is disabled.
Download Common Config enabled	Whether phone will download the common configuration file.
Enable Server Digest	When the feature is enable, if the configuration of server is changed, phone will download and update.
<b>DHCP Option</b>	
Option Value	Configre DHCP option, DHCP option supports DHCP custom option   DHCP option 66   DHCP option 43, 3 methods to get the provision URL. The default is Option 66.
Custom Option Value	Custom Option value is allowed from 128 to 254. The option value must be same as server define.
Enable DHCP Option 120	Use Option120 to get the SIP server address from DHCP server.
<b>SIP Plug and Play (PnP)</b>	
Enable SIP PnP	Whether enable PnP or not. If PnP is enable, phone will send a SIP SUBSCRIBE message with broadcast method. Any server can support the feature will respond and send a Notify with URL to phone. Phone could get the configuration file with the URL.
Server Address	Broadcast address. As default, it is 224.0.0.0
Server Port	PnP port
Transport Protocol	PnP protocol, TCP or UDP.
Update Interval	PnP message interval.
<b>Static Provisioning Server</b>	
Server Address	Provisioning server address. Support both IP address and domain address.
Configuration File Name	The configuration file name. If it is empty, phone will request the common file and device file which is named as its MAC address. The file name could be a common name, \$mac.cfg, \$input.cfg.

	The file format supports CFG/TXT/XML.
Protocol Type	Transferring protocol type , supports FTP、TFTP、HTTP and HTTPS
Update Interval	Configuration file update interval time. As default it is 1, means phone will check the update every 1 hour.
Update Mode	Provision Mode. <ol style="list-style-type: none"> <li>1. Disabled.</li> <li>2. Update after reboot.</li> <li>3. Update at Time interval.</li> </ol>
<b>TR069</b>	
Enable TR069	Enable TR069 after selection
ACS Server Type	Select TR069 Serve type.
ACS Server URL	ACS server address
ACS User	ACS server username (up to is 59 character)
ACS Password	ACS server password (up to is 59 character)
TLS Version	TLS version (TLS 1.0, TLS 1.1, TLS 1.2)
INFORM Sending Period	INFORM signal interval time. It ranges from 1s to 999999s
STUN Server Address	Configure STUN server address
STUN Enable	To enable STUN server for TR069

## 11 W620D Preference Settings

### 11.1 Time Setting

**Setting method:**

When the device is in standby mode, access the device function menu key [Menu] by press OK key>> [Basic] key>> [Time&Date] key, use the up/down navigation keys to edit/time Parameters, and then press [OK] to save.

Configuration Parameter description:

Parameter	Description
Mode	Choose the synchronization server time or manually set it
SNTP Server	SNTP service address
Time Zone	Select Time Zone
Format	Choose a time format from the following formats: <ul style="list-style-type: none"> <li>● DD MMM WW</li> <li>● MMM DD WW</li> <li>● WW DD MMM</li> <li>● WW MMM DD</li> <li>● DD MM YY</li> <li>● DD MM YYYY</li> <li>● MM DD YY</li> <li>● MM DD YYYY</li> <li>● YY MM DD</li> <li>● YYYY MM DD</li> </ul>
Separator	Select the separator between year, month, and day
12 Hours Clock	Display 12 hour clock
Daylight Saving Time	Daylight Saving Time Settings, Disable/Auto/Manual (Web Settings)

## 11.2 Screen Setting

Users can edit screen Parameters by accessing the function menu keys [Menu] by press OK key>> [Basic]>> [Screen]. After editing, click [OK] to save.

### 11.2.1 Backlight

- Set the Backlight Active Level from 1 to 16 when in use, and switch the brightness level between [<] or [>].
- Set the Backlight Inactive Level from 0 to 16 in energy-saving mode, and switch the brightness level between [<] or [>].
- Set the Backlight Time, the value is 1 minute by default, which can be turned off or selected as 15 S/ 30 S/ 1 min/ 2 min/ 5 min/ 10 min/ 30 min/ 1 h/ 2h/ 3h/ 6h/ 15h or customized.

### 11.2.2 Screensaver

Access [Menu] by press OK key>> [Basic]>> [Screen], edit the [Screensaver] Parameters, press the [Left]/[Right] keys to enable/disable the screen saver, set the timeout time, default to 15 seconds, and press the [OK] key to save after completion

### 11.2.3 Sleep

#### Entering sleep mode

- When there is no operation on W620D, it defaults to entering sleep mode for 30 seconds.
- Press the red on-hook key  in standby mode to enter sleep mode.

#### Exit sleep mode

- The device will automatically exit sleep mode upon receiving notifications such as incoming calls.
- Press any key on the device to exit sleep mode.

#### Sleep Mode Settings

- Access the device [Menu] by press OK key>> [Basic]>> [Screen], edit the [Time Out

To Sleep] item, which defaults to 30 seconds. You can disable it or set it to 15 S/30 S/1 min/2 min/5 min/10 min/20 min/30 min.

## 11.3 Audio Setting

### 11.3.1 Ringing Tone

#### Set ring type

- Access the device>> [Menu] by press OK key>> [Basic]>> [Ring], edit the parameters for [Ringtone Type], use the left and right navigation keys to edit the ring type, and press [OK] to save after completion.

#### Set ring volume

- Access the device>> [Menu] by press OK key>> [Basic]>> [Ring], edit the [Headset] and [Handfree] Parameters, use the left and right navigation keys to edit the ringtone volume, and press [OK] to save after completion.

#### Set vibrate mode

- Access the device>> [Menu] by press OK key>> [Basic]>> [Ring], edit the [Vibrate Mode] parameters, use the left and right navigation keys to select enable/disable vibration mode, and press [OK] to save after completion.

### 11.3.2 Voice Volume Setting

#### Set voice volume

- Access the device>> [Menu] by press OK key>> [Basic]>> [Voice Volume], edit the parameters of [Handset Volume], [Handsfree Volume], and [Headset Volume], use the left and right navigation keys to edit the audio volume, and press [OK] to save after completion.

### 11.3.3 Alert Info Setting

#### Set Alert Info

- According to the steps in [5.4 W710D Configuration Management](#), access the created configuration file>>[Settings]>>[Media Settings]>>[Alert Info Ring Settings],

configure the Alert Info.

Configuration Parameter description:

Alert Info Ring Settings	
The value of notification message 1 to notification message 10	Set the value to specify the ring type.
Ring Type	Type1-Type8

### 11.3.4 Tone Settings

- The administrator can set the prompt tone of the device through the W710D-Manager.
- You can either select the country area or customize the area. If the area is selected, it will bring out the following information directly. If you choose to customize the area, you can modify the Dial Tone, Ring BackTone and other information.

#### Set Tone

- According to the steps in [5.4 W710D Configuration Management](#), access the created configuration file>>[Settings]>>[Tone], configure the Tone.

### 11.3.5 Noise Reduction

W620D supports AI Noise Cancellation and Acoustic Shield, which can effectively reduce background noise, even in noisy environments such as streets, factories, or parking lots, to provide users with high-quality calls.

- Acoustic Shield: It's like separating the user's voice from other noises, suitable for situations where the user is close to the device;
- Noise Cancellation: It reduces noise by algorithm, suitable for situations where the noise and the user's voice are about the same size, after the algorithm processing, the call quality may be slightly affected.

Users can choose different noise reduction types in different situations, for example, using the handset for a call is more suitable for using the Acoustic Shield function; using hands-free calling is suitable for using Noise Cancellation. Or choose the appropriate

noise reduction technology according to the actual situation.

### Set Acoustic Shield/Noise Cancellation

- Configured by the administrator in the W710D-Manager  
According to the steps in [5.4 W710D Configuration Management](#), access the created profile >> [Settings] >> [Media Settings] >> [Noise Reduction], enable/disable the Noise Cancellation or Acous Shield, save it.
- Configure on W620D  
During a call, press Softkey- More, select the Noise Cancellation or Acoustic Shield, and press the OK key to enable the feature.

Note: The Noise Cancellation and Acoustic Shield features are both disabled by default.

## 11.4 Greeting Words settings

### Set greeting words

- Access the device>> [Menu] by press OK key>> [Basic]>> [Greeting Words], edit the greeting words and press [OK] to save.

## 12 Function Keys

---

Function keys can be set through terminal devices or configured through W710D web page management function keys.

- **Configure function keys by administrator in W710D Manager**

According to the steps in section [5.4 W710D Configuration Management](#), access the created configuration file>>[Function Keys], configure the DSSKEY or PTT buttons, which can be BLF/Speed Dial/PTT buttons/Intercom, etc. Assign the configuration to the corresponding device and update it.

- **Configure function keys on terminal devices**

In standby mode, press Softkey - Function key/Navigation key - Left key/Navigation key - Right key, or the PTT button on the right to select the function key for editing.

### Function key usage

Dsskeys support the following types:

- Memory Key
  - Speed Dial: In standby or off hook mode, press this button to directly dial the number set by the speed settings.
  - Intercom: Call out the set number through intercom, and when the other party is set to receive intercom calls, they can automatically answer the intercom calls.
  - Voice Mail: Used to configure Voice Mail numbers and lines. When the indicator light is on, it indicates that there is new voice information.
  - Call Forwarding: After the configuration, you can press this key to enable Call Forward Unconditional to a specified number when the device is idle. When the device receives an incoming call, press this key to forward the call to a specified number.
  - Call Park: Used to switch to other devices or locations during a call.
  - BLF (New Call/BXFER/XFER/CONF/DTMF): Used to indicate the status of the subscribed extension (idle, ringing, or calling out); Answer the incoming call from the extension when it is called; If a pick up number is configured, incoming calls can be picked up when the extension rings. The subtypes of BLF are as follows:
    - ✧ BLF/NEW CALL: During a call, pressing this button can initiate a new call

to the subscribed extension without hanging up the current call.

- ✧ BLF/BXFER: During a call, press this button to blindly redirect the call to the subscribed extension.
- ✧ BLF/AXFER: During a call, press this button to transfer the call attendance to the subscribed extension.
- ✧ BLF/CONF: During a call, press this button to invite the subscribed extension to attend the conference.
- ✧ BLF/DTMF: During a call, press this button to send DTMF.
- Presence: Similar to the BLF function key, it is used to indicate the status of subscribed extension numbers. Note that different servers do not support different subscription types.
- Function keys
  - Voice Mail: Display detailed information of voice speakers for all SIP lines.
  - DND: Enter the DND settings interface and enable/disable the DND function.
  - Call hold: Keep/resume the current call.
  - Call transfer: Enter the transfer interface, with the same function as the Softkey transfer button.
  - Phonebook: Enter the phone book interface.
  - Redial: Redial the last dialed number.
  - Pickup: When other devices ring, press this button to enter the dialing interface. Enter the ringing extension number to pick up the call.
  - Join: Join all established calls along the way.
  - Call forward: Enter the call forwarding settings interface.
  - Call Logs: Enter the call history viewing interface.
  - Flash: Pressing this button during a call will keep the current call, and another line will start dialing. You can hear the dialing tone.
  - Memo: Enter the memo interface.
  - Headset: Answer incoming calls or switch to the headset channel during calls through headset mode.
  - Release: Press this button to return to the standby interface when there is no call; Pressing this key during a call can end all calls and return to the standby interface.

- Lock Phone: When the keyboard lock function is enabled, press this button to manually lock the keyboard.
- SMS: Enter the SMS interface.
- Call Back: Callback the number of the last incoming call.
- Hide DTMF: Enter the hide DTMF settings interface.
- Intercom: Open the dial and call out the entered number through intercom.
- Group Listen: Press this button during a call to play the other person's voice through the earpiece/earphone and hands-free.
- Prefix: Configuration number prefix. When dialing, press this button to automatically add a prefix number.
- End: Ends the current call.
- Disposition: This feature relies on Broadsoft servers and is a method of recording call information in the call center.
- Escalate: This feature is related to Broadsoft servers, and during a call, press to send the corresponding SIP message to the server.
- Trace: This feature is related to Broadsoft servers and sends call information during or after a call.
- Handsfree: Enter the hands-free dialing number or switch the hands-free channel.
- Answer: Press the button to answer an incoming call.
- Local contact: Enter the local contact interface.
- XML Group: Enter the cloud phone book interface.
- Auto Headset: enable or disable the Auto Headset mode, which is enabled by default.
- Dsskey Page 1: Enter the Dsskey display/settings interface on the first page.
- Dsskey Page 2: Enter the Dsskey display/settings interface on the second page.
- DTMF: Press this button during a call to send the configured values in sequence to the remote end.
- URL: Access the configured remote URL address, which can be set to an XML phone book address, etc.
- BLF List key: This function depends on the Broadsoft server. Add the numbers that

need to be subscribed to in the server to the group, use the URL address of the group to subscribe to all the numbers in the group, and display the corresponding number, name, and status on the indicator light of the BLF List key. The BLF List is automatically issued by the server based on configuration, without the need for users to manually configure values and names.

- XML Browser: Place the configured XML file on the HTTP/HTTPS server, press this button to retrieve the XML content and perform corresponding actions based on the content.

## 13 W710D Network Settings

---

### 13.1 Ethernet Settings

#### IPv4 Settings

- There are two modes to choose from for IPv4 network types: DHCP and Static IP.
- When the network type is set to DHCP, the phone is issued a network IP address by the DHCP server (router).
  - DNS Server Configured by DHCP: enabled by default, for domain name resolution.
  - Time Synchronized Via DHCP: disabled by default. It controls whether using the DHCP server time.
- When the network is set to Static IP, the IP address needs to be manually set.
  - IP address: Fill in the IP address you want to set.
  - Subnet Mask: Set subnet mask.
  - Default Gateway: used to achieve network interconnection and can be filled in according to one's own needs.
  - Primary DNS server: The IP address of the primary DNS server
  - Secondary DNS server: The IP address of the backup DNS server.

#### IPv6 Settings

- There are two types of IPv6 network modes available: DHCP and Static IP.
- When the network type is set to DHCP, the phone is issued a network IP address by the DHCP server (router).
  - DNS Server Configured by DHCPv6: enabled by default, for domain name resolution.
  - Time Synchronized Via DHCPv6: disabled by default. It controls whether using the DHCP server time.
- When the network is set to Static IP, the IP address needs to be manually set.
  - IP address: Fill in the IPv6 address you want to set.
  - Prefix Length: The number of IPv6 prefix bits, where the prefix represents the network bit, similar to the subnet mask of IPv4.

- Default Gateway: used to achieve network interconnection and can be filled in according to one's own needs.
- Primary DNS server: The IP address of the primary DNS server
- Secondary DNS server: The IP address of the backup DNS server.

## 13.2 Network Mode

### Network Mode

- There are three modes to choose from for the phone IP Mode: IPv4, IPv6, and IPv4&IPv6. Users can set the network mode of W710D in the Manager webpage>>[Network]>>[Network Mode].

## 13.3 Web Server Type Settings

### Setting method

- Visit the Manager webpage>>[Network]>>[Server Port]>>[Server Port Settings] to configure the web server type. You can configure parameters such as web login protocol type and login port.

### Configuration Description

- Web Server Type: Reboot to take effect after settings. Optionally, the web page login is HTTP/HTTPS.
- Web Logon Timeout: Default as 15 minutes, the timeout will automatically exit the login page, need to login again.
- Web auto login: After the timeout does not need to enter a user name password, will automatically login to the web page.
- HTTP Port: The default is 80. If you want system security, you can set ports other than 80. Such as :8080, webpage login: HTTP://ip:8080
- HTTPS Port: The default is 443, the same as the HTTP port.

## 13.4 VPN

### Function Description

- Virtual Private Network (VPN) is a technology to allow device to create a tunneling connection to a server and becomes part of the server's network. The network transmission of the device may be routed through the VPN server.
- For some users, especially enterprise users, a VPN connection might be required to be established before activate a line registration. The device supports two VPN modes, Layer 2 Transportation Protocol (L2TP) and OpenVPN.
- The VPN connection must be configured and started (or stopped) from the device web portal.

### L2TP Setting Method

- To establish a L2TP connection, users should log in to the device web portal, open webpage [Network] >> [VPN]. In VPN Mode, check the "Enable VPN" option and select "L2TP", then fill in the L2TP server address, Authentication Username, and Authentication Password in the L2TP section. Press "Apply" then the device will try to connect to the L2TP server.
- When the VPN connection established, the VPN IP Address should be displayed in the VPN status. There may be the delay of the connection establishment. User may need to refresh the page to update the status.
- Once the VPN is configured, the device will try to connect with the VPN automatically when the device boots up every time until user disable it. Sometimes, if the VPN connection does not establish immediately, user may try to reboot the device and check if VPN connection established after reboot.

#### Note:

The device only supports non-encrypted basic authentication and non-encrypted data tunneling. For users who need data encryption, please use OpenVPN instead.

### OpenVPN setup method

- To establish an OpenVPN connection, user should get the following authentication and configuration files from the OpenVPN hosting provider and name them as the

following,

- OpenVPN Configuration file: client.ovpn
- CA Root Certification:ca.crt
- Client Certification:client.crt
- Client Key:client.key
- User then upload these files to the device in the web page [Network] >> [VPN], select OpenVPN Files.
- Then user should check “Enable VPN” and select “OpenVPN” in VPN Mode and click “Apply” to enable OpenVPN connection.
- Same as L2TP connection, the connection will be established every time when system rebooted until user disable it manually.

## 13.5 VLAN

VLAN (Virtual Local Area Network) technology can divide a LAN into multiple logical LANs - VLANs, each VLAN is a broadcast domain, and broadcast packets are limited within one VLAN.

W710D supports obtaining VLAN IDs through LLDP, CDP, DHCP, and manual settings.

### LLDP (Link Layer Discovery Protocol)

- Visit W710D webpage>>[Network]>>[Advanced]>>Link layer discovery protocol, configure LLDP parameters:
  - Enable LLDP: Enable LLDP protocol functionality.
  - Packet Interval: LLDP message sent periodic interval.
  - Enable Learning Function: Enable LLDP self-learning VLAN configuration function

### CDP (Cisco Discovery Protocol)

- Visit W710D webpage>>[Network]>>[Advanced]>>Cisco Discovery Protocol, configure CDP parameters:
  - Enable CDP: Enable CDP protocol functionality.
  - Packet Interval: CDP message sent periodic interval.

## DHCP VLAN

- Visit W710D webpage>>[Network]>>[Advanced]>>DHCP VLAN settings, configure DHCP VLAN parameters:
  - Option Value: Enable or disable obtaining VLAN ID through DHCP Option.
  - DHCP Option VLAN: Set the Option value, 128-254, and obtain the VLAN value through DHCP

## Set VLAN Manually

- WAN VLAN Settings: Visit the W710D webpage>>[Network]>>[Advanced]>>[WAN VLAN Settings], manually set the WAN port VLANID:
  - Enable VLAN: Enable manual setting of WAN port VLAN function
  - WAN VLAN ID: Set WAN language ID.
- LAN VLAN Settings: Visit the W710D webpage>>[Network]>>[Advanced]>>[WAN VLAN Settings], manually set the LAN port VLAN ID:
  - LAN VLAN mode: Enable or disable the setting of LAN port VLAN. When enabled, the LAN port VLAN mode can be set to Follow WAN, which is the same as the WAN port VLAN ID; Or manually set the LAN port VLAN.
  - LAN VLAN ID: Set LAN ID.

## 14 W620D Connecting Peripherals

---

### 14.1 USB Flash Drive

W620D can export log files and perform upgrades through USB. Please refer to [16 Troubleshooting](#) for the method of upgrading and exporting logs through USB.

**Note:**

- You need to use a U Disk with a TypeC interface or use a TypeC USB adapter.
- Please use a FAT 32 format U Disk.

### 14.2 Wired Headset

The device supports wired Headset with a Type C headset interface, enabling the Headset to play incoming call prompts, earphone calls, and more.

After the device is connected to the headsets, the status bar displays the headset icon, indicating that the headset channel is available.

### 14.3 Bluetooth Headset

The W620D device is equipped with BT5.0 built-in.

**Setting method**

- The device is in default standby mode. Go to [Menu] by press OK key>>[Basic]>>[Bluetooth], select Bluetooth, and use the navigation keys - left/right to turn it on. If no pairing is displayed, press the [Scan] button to enter the Bluetooth search interface for scanning, select the scanned Bluetooth device to connect.

## 15 Security

---

### 15.1 W620D Menu Password

The menu password is used to access the [Menu] by press OK key>>[Advanced] directory, and users can customize the menu password. Press OK key to access the device [Menu] by press OK key>>[Advanced], enter the current menu password (default password is 123), access [Security]>>[Menu Password], and set the parameters:

- Current Password: The password set for you, with a default password of 123.
- New Password: is the new menu password you want to reset.
- Confirm Password: Enter a new menu password that must be exactly the same as the new password.

After setting, the password will take effect immediately, and a new password is required to enter the device menu.

### 15.2 W710D Webpage Password

Users can customize and modify their webpage login password by accessing the W710D webpage [System]>>[User Configuration]>>[User Account] and selecting the account to modify it.

- Old Password: Enter the webpage login password
- New Password: Enter the login password that needs to be modified
- Confirm Password: Enter the login password that needs to be modified again

After changing the password, it will automatically log out and you need to enter a new password to log in again.

### 15.3 W620D Keyboard Password

The keyboard Password is used to unlock the keyboard after the phone keyboard is locked.

### Set Keyboard Lock

- Access the device [Menu] by press OK key>>[Advanced], enter the current menu password (default password is 123), access [Security]>>[Keyboard Password], select the Keyboard Status, and set the Keyboard Timeout time.
  - Keyboard Status: Menu Keys/DSS keys/All keys. The keyboard lock will lock for the aforementioned keyboard range after timeout.
  - Keyboard Timeout: Lock the keyboard after the timeout period.

### Set keyboard Password

- Access the device [Menu] by press OK key>>[Advanced], enter the current menu password (default password is 123), access [Security]>>[Keyboard Password]>>[Set Password], and modify the keyboard Password.
- Current Password: The current password.
- New Password: is the new menu password you want to reset.
- Confirm Password: Enter a new menu password that must be exactly the same as the new password.

### Unlock

- After the keyboard is locked, the device status bar will display a keyboard lock icon. At this time, pressing any key will prompt for a password. After entering the keyboard Password, the keyboard can be unlocked.
- When the Keyboard Status is disabled, long press the "#" key to lock and then long press the "#" key again to unlock.
- When the Keyboard Status is enabled the Keyboard Timeout is 0, long press the "#" key to lock and enter the keyboard password to unlock.

## 15.4 W710D Web Filter

Users can set that only machines with a certain IP segment are allowed to access configuration management devices

Access the W710D webpage [Security]>>[Web Filter], adding and removing IP segments are accessible. Configure the starting IP address within the start IP, end the IP address within the end IP, and click [Add] to submit to take effect. A large network segment can be set, or it can be divided into several network segments to add. If the user wants to delete, select the network segment to be deleted from the Web Filter Table, and then click [Delete] to take effect.

Enable Web Filter: configure enable/disable Web Filter; Click the [Apply] button to take effect.

Enable web page filtering: configure to enable/disable web page access filtering; Click the [Submit] button to take effect

 **Note:**  
 If the device you are accessing is in the same network segment as the phone, please do not configure the filter segment of the web page to be outside your own network segment, otherwise you will not be able to log in the web page.

## 15.5 W710D Mutual Authentication

W710D supports mutual authentication both of HTTPS and SIP TLS.

### Certificate Management

- Device Certificate: Visit the W710D webpage [Security]>>[Device Certificate] and set the device certificate parameters:
  - Device Certificate: Select the device certificate sent by the device for authentication, and you can choose the default built-in certificate of the device; You can also choose to customize the certificate and use the certificate uploaded by the user.
  - Import Certificate: Upload a custom device certificate.
  - Certificate List: displays a list of uploaded custom device certificates, only one

custom device certificate can be uploaded. When no custom certificate is uploaded, the certificate list appears empty

- Trust Certificate: Visit the W710D webpage [Security]>>[Trust Certificates], set the trust certificate parameters:
  - Permission Certificate: used to confirm whether server certificate authentication is enabled.
  - Common Name Validation: Whether to enable regular name verification.
  - Certificate Mode: Select the certificate module to use, with the following parameter descriptions:
    - ✧ All Certificates: Choose to trust all certificate modules, including custom uploaded trust certificate lists and device built-in trust lists.
    - ✧ Default Certificates: Select the trust certificate list built into the trusted device.
    - ✧ Custom Certificates: Select the trust custom uploaded trust certificate list.
  - Import Certificates: Used to import trust certificates on the server side.
  - Certificates List: displays a list of server trust certificates uploaded by the user.

### Mutual Authentication Description

- Upload the device certificate used by W710D to the server's trust certificate list, and confirm that there is a device certificate for the device in the server's trust certificate list. Please confirm with the server administrator.
- Visit the W710D webpage [Security]>>[Trust Certificates]>>[Import Certificates], upload the device certificate from the server to the trust certificate list of the W710D device, and select the trust certificate module to use.

## 15.6 W710D Firewall

### Set up a network firewall

- Accessing the W710D webpage>>[Security]>>[Firewall], you can set whether to enable the input through this page, output firewall and set the firewall input and output rules. Using these Settings can prevent some malicious network access, or restrict internal users access to some resources of the external network, which can improve security.

### Function Description

- Firewall rule set is a simple firewall module. This feature supports two types of rules: input rules and output rules. Each rule is assigned an ordinal number, allowing up to 10 for each rule.
- After setting the parameters, click [Add] and a new item will be added in the firewall output rule.
- Select the list you want to delete, click [Delete] to delete the selected list.

Parameter Description:

Parameter	Description
Enable Input Rules	Indicates that the input rule application is enabled.
Enable Output Rules	Indicates that the output rule application is enabled.
Input/Output	To select whether the currently added rule is an input or output rule.
Deny/Permit	To select whether the current rule configuration is disabled or allowed;
Protocol	The types of filtering protocols: TCP   UDP   ICMP.
Src Port Range	Filter port range
Src Address	Source address can be host address, network address, or all addresses 0.0.0.0; It can also be a network address similar to *.*.*.0, such as: 192.168.1.0.
Dst Address	The destination address can be either the specific IP address or the full address 0.0.0.0; It can also be a network address similar to *.*.*.0, such as: 192.168.1.0.
Src Mask	Is the source address mask. When configured as 255.255.255.255, it means that the host is specific. When set as 255.255.255.0, it means that a network segment is filtered.
Dst Mask	Is the destination address mask. When configured as 255.255.255.255, it means the specific host. When set as 255.255.255.0, it means that a network segment is filtered.

## 16 Troubleshooting

---

### 16.1 Obtain System Information

#### 16.1.1 Obtain Information for W710D

##### Obtain System Information through W710D

Visit the W710D webpage>>[System]>>[Information] page to obtain information. The following information will be provided:

- System Information: Display device Model, Hardware, Software, Uptime, Last Uptime, WAN Speed, MEMInfo, System Time, SN information.
- Network: Display device Network Mode, MAC address, Ethernet IP, Subnet Mask, Default Gateway information.

##### Obtain System Information through W620D

When W620D is connected to Manager/Base and the connection status is normal, the IP address, firmware version number, MAC address, RFPI, Area and currently selected country/region(Frequency band) of the Manager in the system can be obtained by accessing W620D device>>[Menu] by press OK key>>>[Status]>>[Manager].

#### 16.1.2 Obtain system information for W620D

##### Obtain Information through W710D

After W620D successfully connects to Manager/Base, the administrator can view the information of the W620D terminal on the W710D Manager webpage>>[Handset], including the terminal's Registered status, IPUI, internal extension number, SIP Account, Name, Model, Software version number, and current connected Base.

##### Obtain Information through W620D

Access the device's [Menu] by press OK key>>>[Status] to obtain the following status information for W620D:

- Manager: displays the IP address, Firmware version, MAC address, RFPI and Area

information of manager which the device connected.

- Network: displays the device's Network Mode, Network IP, and RSSI(signal strength) information.
- Phone: Display device MAC address, Bluetooth MAC address, IPUI, Model, Hardware version, Software version, Uboot version, RAM, ROM and Uptime information of the device.
- Account: Display the name/number of the device's registered account and registration status information. Account 1-4 is the SIP Account, and account 5 is the internal extension number.

## 16.2 W620D Power On / Off

Please refer to [4.2 W620D power on/off](#) operation.

## 16.3 Reboot

### Reboot W710D

- Visit the W710D webpage>>[System]>>[Reboot], click the Reboot button to reboot .
- Simply unplug the power and reboot the device.

### Reboot W620D

- Visit the W710D Manager webpage>>[Handset]>>[Maintenance], select the online terminal, and click the Reboot button. Multiple terminals can be selected at once for reboot .
- Visit W620D>>[Menu] by press OK key>>[Basic Settings]>>[Reboot System], select OK to reboot .

## 16.4 Reset Device to Factory Default

Resetting Device to Factory Default will erase all the user's configuration, preference, database and profiles on the device and restore the device back to the state as factory default.

### Reset W710D

- Visit the W710D webpage>>[System]>>[Configuration]>>[Reset Devices], click the Reset button to reset.
- Long press the Reset button on the W710D device to reset.

### Reset W620D

- Visit W620D>>[Menu] by press OK key>>[Advanced], then enter the password to enter the interface, select [Factory Reset], click OK to reset.
- Long press the OK button on the standby interface of W620D to reset.

## 16.5 Screenshot

### Note:

During the process of downloading screenshots, capturing packets, and capturing logs, do not let device sleep.

If there is a problem with the terminal device, screenshots can help technicians locate the functional location and clarify the problem phenomenon.

### Take screenshots of connected terminals through W710D Manager

Visit the W710D Manager webpage>>[Handset]>>[Diagnosis], select the online device, click the screenshot button, and save the pictures (you can capture them in the interface with problems). Save the image and send it to the technical personnel to locate the issue.

## 16.6 Network Packets Capture

Network packets capture can help technicians analyze and locate problems.

### Capture packets of W620D through Manager

Visit the W710D Manager webpage>>[Handset]>>[Diagnosis], select the online device, click the start packet capture button, and perform the operation of reproducing the problem. After the problem occurs, click the end packet capture button to save the data

packet. Users can analyze data packets or send them to technical support email.

### Capture packets for W710D

Visit the W710D Manager web page>>[System Tools]>>[LAN Packet Capture], click the [Start] button, and a message will pop up asking the user to save the captured file. At this point, users can perform related operations, such as starting/stopping the line or making a phone call. After completion, click the [Stop] button on the webpage. All network packets during the device period are saved in files. Users can analyze data packets or send them to technical support email

## 16.7 Get Log Information

Log information can help technicians analyze and locate problems.

### Obtain log for W620D through Manager

Visit the W710D Manager webpage>>[Handset]>>[Diagnosis], select the online device, click the Settings button, enable logging, and set the logging level to Debug. Perform the operation of reproducing the problem. After reproducing the problem, click on Export Log and save the log file. Users can analyze log information or send it to technical support email.



#### Note:

When the system log level of the terminal is Debug, it will have a certain impact on the performance of the terminal, such as shortened standby time, delayed response, etc. After the problem is resolved, please set the log level to the default Error.

### Obtain log information for W710D



Visit the W710D Manager webpage>>[System Tools]>>[Tools]>>[Syslog], Enable Syslog, set APP Log Level to debug and Enable Log, click the [Apply] button to save. Follow the steps of the problem until it appears, then click the [Export Log] button, and Save to analyze locally or send the logs to technical personnel to locate the problem.

## 16.8 W620D USB/USB Drive Upgrade

When there are some abnormal problems with the device, you can try to upgrade and recover the software through USB under the guidance of technical support personnel.

Please obtain the steps and tools for upgrading USB/USB drives from technical support personnel.







## 16.9 Common Trouble Cases

Fault cases	Solution
Device could not boot up	<ol style="list-style-type: none"> <li data-bbox="549 1043 1348 1196">1. First consider the situation that the battery has been exhausted, and charge the device. Please use the charger configured at the time of purchase when charging.</li> <li data-bbox="549 1211 1348 1364">2. If you see the phone enter "POST mode", it means that the phone system is damaged. Please contact technical support to help you restore the phone system.</li> </ol>
The device is frozen on a screen and cannot be operated	<ol style="list-style-type: none"> <li data-bbox="549 1391 1348 1594">1. Hold down the red hang-up button to force power off, and hold down the red hang up button again to power on. After the power on, you can export logs and send them to the technical support.</li> </ol>
Device could not register to a service provider	<ol style="list-style-type: none"> <li data-bbox="549 1626 1348 1890">1. Please check whether the phone is connected to the network. The phone needs to be connected to a wireless network, and check whether the wireless icon is normal. If the icon shows  or , the network is unavailable, please check the network facilities.</li> <li data-bbox="549 1906 1348 1998">2. Please check whether the phone has an IP address. Check the system information. If the IP address is Negotiating..., it</li> </ol>

	<p>means that the phone has not obtained an IP address.</p> <p>Please check whether the network configuration is correct.</p> <p>3. If the network connection is good, please check your line configuration again. If all configurations are correct, please contact your service provider for support, or follow the instructions in "<a href="#">16.6 Network Packet Capture</a>" to obtain a registered network packet and send it to the manufacturer's support mailbox to help analyze the problem.</p>
<p>No Audio or Poor Audio in Handset</p>	<p>1. Please check whether the headset is connected, the headset icon  is displayed in the upper right corner. After connecting the headset, the earpiece channel cannot be used; after unplugging the headset, the earpiece channel can be used.</p> <p>2. At this point the network bandwidth and latency may not be suitable for audio calls.</p>
<p>Poor Audio or Low Volume in Headset</p>	<p>1. Please use the Headset provided by manufacturer.</p> <p>2. The network bandwidth and delay may be not suitable for audio call at the moment.</p>
<p>Audio is chopping at far-end in Hands-free speaker mode</p>	<p>This is usually due to loud volume feedback from speaker to microphone. Please lower down the speaker volume a little bit, the phenomenon will be gone.</p>

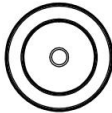

















## 17 Appendix

### 17.1 Appendix I - W620D Key Icons

Icon	Description
	Programmable keys, the default is PTT Key, which can be set to function key/speed dial key, etc.
	Volume keys, in standby or ringing state: increase or decrease ringer volume During a call: increase or decrease the volume of the headset, handset, hands-free
	Softkey
	Up, down, left, right navigation keys, and OK key By default, the functions of each button during standby: Up key: Call history Down key: status Left key: Enter the DSSKEY Page1 settings page Right key: Enter the DSSKEY Page2 settings page OK key: Long press to Factory Reset.
	Return to the homepage; Hang up the call; Enter sleep mode; Exit sleep mode Long press to power on/off
	Dial; switch the call channel
	Phone book keyboard
	Hands-free key, turn on/off the hands-free channel

### 17.2 Appendix II - W620D Status and Notification Icons

Display icons	Icon Explanation
---------------	------------------





	In hands-free mode
	In headset mode
	In handset mode
	Mute activated
	Silent mode
	Call is on hold
	Auto-answering activated
	Call forward activated
	Do not disturb activated (Red)
	Bluetooth device paired connection
	Enable Bluetooth and no bluetooth device paired connection
	Keypad locked
	Forward call(s)
	Missed call(s)
	Received call(s)
	Dialed call(s)
	Network connected
	Network disconnected





	Network anomaly
---	-----------------

### 17.3 Appendix III - W620D LED State Definition

Type	LED lights	State
Status indicator light	Yellow On	Charging
	Green On	Fully Charged
	Red and Yellow Blinking alternately	Low Battery
	Yellow Breathing Blinking	Missed calls or unread messages
	Yellow Blinking Quickly	Ringling

### 17.4 Appendix IV - W620D Menu Icons

Icon	Description
 Status	View the status of Manager, Network, Devices, and Accounts.
 Network	Connect to Manager/Base network
 Basic	Set preference settings.
 Contact	Access all contacts.

 Messages	View Voice Mails and SMS servers.
 CallLog	Access the call history list.
 Features	Set functions such as Call Forwarding, Auto Answer, Call Waiting, DND, Intercom, and Ban Anonymous Call.
 Application	Set up Memo and Export logs through USB drive
 Advanced	Set Security, Upgrade, and Factory Reset.

## 17.5 Appendix V - W620D Keyboard Character Query Table

Icon	Input Method	Keys	Characters Of Each Press
123	Number	1	1
		2	2
		3	3
		4	4
		5	5
		6	6
		7	7
		8	8

		9	9
		0	0
		*	*.:/@ [],+ - _='? \ " ; ()<>{}#
		#	#
abc	Lowercase letters	1	@:; ()<>[] {}
		2	a b c
		3	d e f
		4	g h i
		5	j k l
		6	m n o
		7	p q r s
		8	t u v
		9	w x y z
		0	(space)
		*	.,*/+ -: _='? \ "
		#	#^!&\$% pound
		ABC	Upper Case Alphabets
2	A B C		
3	D E F		
4	G H I		
5	J K L		
6	M N O		
7	P Q R S		
8	T U V		
9	W Z Y X		
0	(space)		
*	.,*/+ -: _='? \ "		
#	#^!&\$%£¥¤~¡¿§		
2aB	Number/Letter Keyboard		
		2	2 a b c A B C
		3	3 d e f D E F

		4	4 g h I G H I
		5	5 j k I J K L
		6	6 m n o M N O
		7	7 p q r s P Q R S
		8	8 t u v T U V
		9	9 w z y x W Z Y X
		0	0
		*	.*/@[],+_-=?\";()<>{}
		#	# ^!&\$%£¥α~¡¿\$
aB2	Number/Letter Keyboard	1	1
		2	a b c A B C2
		3	d e f D E F3
		4	g h I G H I4
		5	j k l J K L5
		6	m n o M N O6
		7	p q r s P Q R S7
		8	t u v T U V8
		9	w z y x W Z Y X9
		0	0
		*	.*/@[],+_-=?\";()<>{}
		#	# ^!&\$%£¥α~¡¿\$

## 17.6 Appendix VI - W710D LED Status Definition

Type	LED lights	State
WAN LED	On	Successfully connected to the local area network
	Flash	Network anomalies such as IP conflict or failure to obtain IP
	Off	No network cable inserted

Type	LED lights	State
ROLE LED	On	Device works as Manager
	Flash	Device works as Base
DECT LED	On	Base successfully connected to Manager
	Flash	There are active calls in the system
	Off	Base not connected to Manager