

Fanvil

SIP Video Intercom i18S

Quick Installation Guide



www.fanvil.com

Table of Contents

1. Package Contents.....	3
2. Physical Specifications.....	4
3. Intercom Topological Graph.....	7
4. Installation.....	8
5. Searching Intercom.....	11
6. SIP Setting.....	12
7. Intercom Settings.....	16

1 Package Contents



Door Phone



Connectors



**Quick Installation
Guide**

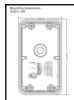

Mounting Template



**Screw and
Screwdriver**

② Physical Specifications

Device size	223 x 130 x 74mm
Weight	1800g

1) Front Panel

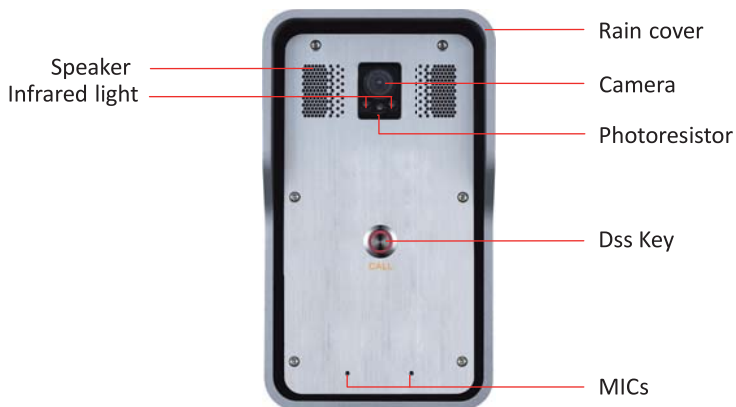

Interface	Description
Camera	Get the video.
Infrared light & Photoresistor	The Compensate for lack of ambient light.
Speaker	The intercom has a built-in speaker for convenient communication and alert use.
MIC	The intercom has a built-in microphone hidden in the pinhole located on the front panel.

Button Definition

Button	Description
DSS Key	Press the Button, intercom calling

LED Definition

LED	Status	Description
	Blinks per second	On call/Hold
	With flashing rapidly	Network failure or not connected
	Always-on	SIP Registration succeeded

2) Port Definition

After removing the Back Panel of device, there are one terminal block connectors for Power interface and control input and outputs as shown in the picture below.

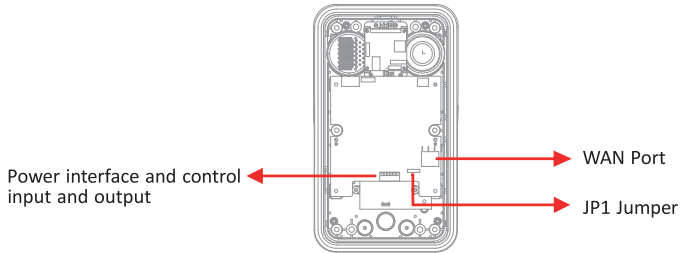

Network Connector



Power and Control interfaces



1	2	3	4	5	6	7
+DC12V	VSS	NC	COM	NO	S-IN	S-OUT
12V DC Input		Control output			Control input	

JP1 Jumper

The control output has two power modes, as shown in the following figure (The default is “**Passive Mode**”).

Passive Mode: When the output device current is more than 12V/500mA, need to use the external drive mode, the control output interface for short circuit output control.

Active Mode : When the output device current is less than 12V/500mA, can use the internal drive mode, the control output interface is 12V DC output.



Jumper in passive mode



Jumper in active mode

Wiring instructions

NO: Normally Open Contact

COM: Common Contact

NC: Normally Close Contact

3 Intercom Topological Graph

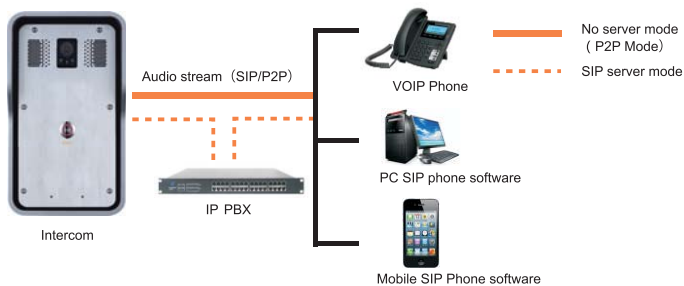
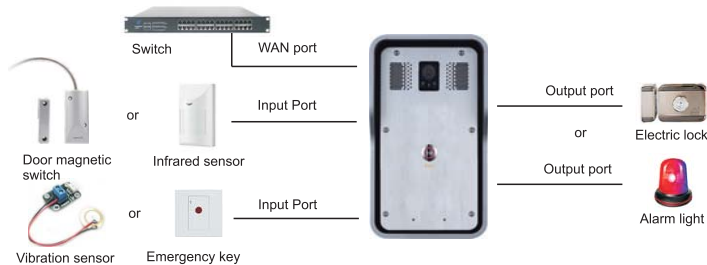

Users can call the same group of people through the VOIP phone, PC or mobile phone SIP phone software, and realizes remote control to the device. (Such as a door lock, alarm lamp etc.)

3 Installation

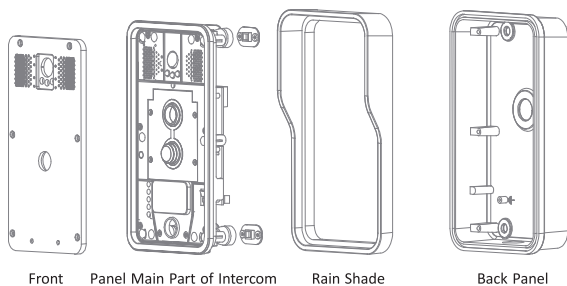

Figure 1 Three Major Parts of i185

Step 1: Installation preparation

A. Check the following contents:

- Hex screwdriver x 1
- RJ45 plugs x 2 (1 spare)
- TA5 x 40mm screws x 4
- 35mm screw anchors x4

B. Tools that may be required:

- Hex wrench
- Phillips screwdriver (Ph2 or Ph3),hammer, RJ45 crimping
- Electric impact drill with an 6mm drill bit

Step 2: Drilling

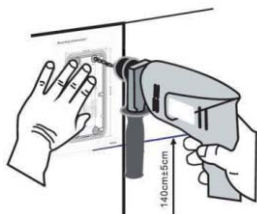

Figure 2 Wall Mounting

4 Installation

- A. Place the mounting template with dimensions on the surface of a wall in a desired flat position.
- B. Use an electric drill to drill the 4 holes marked on the mounting template. It is recommended to drill about 50mm deep. Remove the template when finishing drilling.
- C. Push or hammer screw anchors into the drilled holes.

Step 3: Removing hanging shell

- A. With L-shaped screwdriver, unpack the front panel as diagram(3) (Counter-clockwise) and (4)

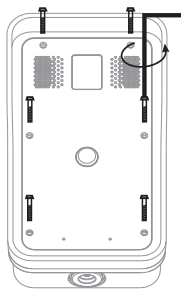

Figure 3

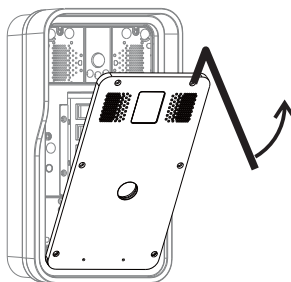

Figure 4

- B. After taking off the 6 conductive sponges in the plastic shell, use the cross screwdriver to remove the 6 screws on the plastic shell and remove the rain cover from the plastic shell. Then separate the plastic shell from the rear shell as diagram (5).

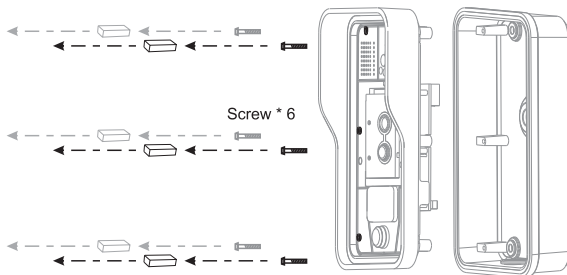

Figure 5

Step 4: Back panel fixing and cabling

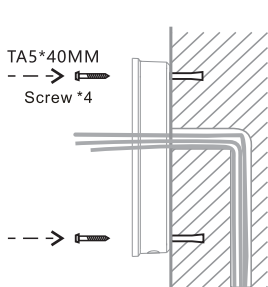

Figure 6

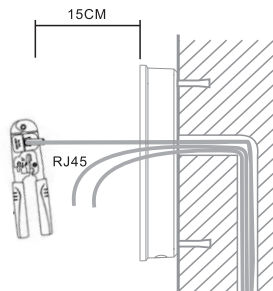

Figure 7

- Select the hole for cable supply, 15cm to 20cm cable length is recommended.
Note: The direction of the cable hole on back panel is pointing down.
- With 4 TA5*40mm screws, tighten the back panel on the wall as diagram(6).
- Connect the cables of RJ45, power, and input Output to the motherboard sockets as mentioned in connectors description (refer to JP1 jumper).
- Test whether there is electricity by doing the following:
Press the # button for 3 seconds to get the IP address of intercom by voice.
check Input and output devices installation.
Note: Do not proceed mounting until you have finished the electric checking.

Step 4: Mounting

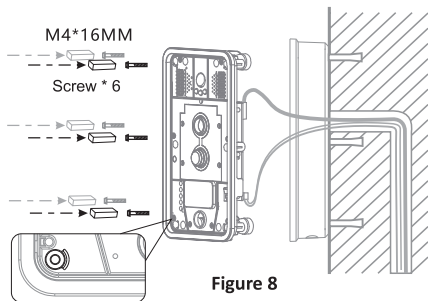

Figure 8

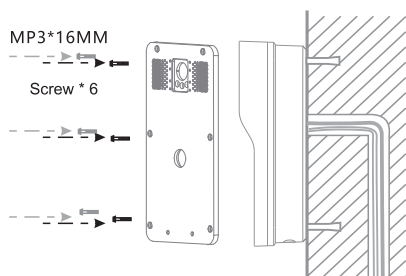

Figure 9

- After locking the 6 screws into the corresponding position of the plastic housing, the 6 conductive sponges is loaded into a screw hole. As shown in Fig. 8, the rear shell is locked.
Note: This sponge can enhance the ESD protection function of the product. Kindly suggest that it should not be ignored!
- Push the front panel into the plastic frame, and tighten it with 6 screws as diagram(9).
Note: Make sure the screws have been tightened properly for better waterproof effect.

5 Searching Intercom

There are two methods as shown below to search the device.

Method 1:

Open the iDoorPhone Network Scanner. Press the Refresh button to search the device and find the IP address.

(Download address <http://download.fanvil.com/tool/iDoorPhoneNetworkScanner.exe>)

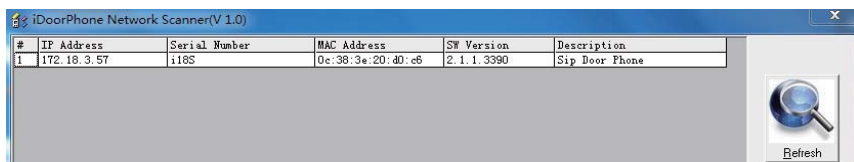

Method 2:

Press and hold the “#” key for 3 seconds and the intercom will report the IP address by voice.

In addition device provides the device surface DSS key operation to switch IP address acquisition mode: long press the DSS key for 10 seconds, to be issued by the speaker Beep, and then press the DSS key three times, the beep stops. Wait 10 seconds, after the success of the system automatically broadcast the current IP address.



Default Setting	
Default DHCP Mode	Not enabled
Static IP Address	192.168.1.128
Default Web Port	80
Default Login User Name	admin
Default Login Password	admin
Display IP address	Hold # for 3 seconds to display by voice
Search Tools	iDoorPhone Network Scanner

6 Installation

Step 1: Log in the intercom

Input IP address (e.g. http://192.168.1.149) into address bar of PC's web browser.

The default user name and password are both admin.



A screenshot of a web browser's login page. It features a light blue background with a white rounded rectangle containing the login form. The form has three input fields: 'User:' with an empty text box, 'Password:' with an empty text box, and 'Language:' with a dropdown menu currently set to 'English'. Below these fields is a 'Logon' button.

Step 2: Add the SIP account.

Set SIP server address, port, user name, password and SIP user with assigned SIP account parameters.

Select "Activate", and then click Apply to save this setting.



A screenshot of a web interface for configuring SIP settings. On the left is a dark red sidebar with a menu: System, Network, Line (selected), Intercom settings, Security settings, and Function Key. The main content area has a top bar with 'SIP' and 'Basic Settings'. Below this, there's a 'Line' dropdown set to 'SIP 1'. Under 'Basic Settings >>', there are several fields: 'Line Status' (Registered), 'Phone number' (5528), 'Display name' (5528), 'Authentication Name' (5528), 'Authentication Password' (*****), and 'Activate' (checked). To the right are fields for 'SIP Proxy Server Address' (172.18.1.88), 'SIP Proxy Server Port' (5060), 'Backup Proxy Server Address', 'Backup Proxy Server Port' (5060), 'Outbound proxy address', 'Outbound proxy port', and 'Realm'. Below these are sections for 'Codec Settings >>' and 'Advanced Settings >>'. At the bottom center is an 'Apply' button.

Step 3: Setting DSS key

Set the DSS key as shown below for quick start. Click "Apply" to save this setting.

Type: Hot Key

Number 1: The DSS Key will dial to this Number 1.

Number 2: If Number 1 is unavailable, it will be forwarded to Number 2.

Line: Working line

Subtype: Speed dial

The screenshot shows the 'Function Key Settings' page. On the left is a navigation menu with 'Function Key' selected. The main content area is titled 'Function Key Settings' and contains a table for key configuration, 'Advanced Settings' with various checkboxes and dropdowns, and a table for time settings.

Key	Type	Number 1	Number 2	Line	Subtype
DSS Key 1	Hot Key	8102		SIP1	Speed Dial
DSS Key 2	None			SIP1	Speed Dial

Advanced Settings

Use Function Key to Answer: Enable
Use Hot Key to Hangup: Enable
Hot Key Dial Mode Select: Main-Secondary

Call Switched Time: 16 (5-50)S
Day Start Time: 06:00 (00:00-23:59)
Day End Time: 18:00 (00:00-23:59)

Apply

Step 4: Security Settings

The screenshot shows the 'Security Settings' page. On the left is a navigation menu with 'Security settings' selected. The main content area is titled 'Input Settings' and contains sections for 'Input Settings', 'Output Settings', and 'Alert Trigger Setting'.

Input Settings

Input Detect
Trigger Mode: Low Level Trigger(Close Trigger) Alert message send to server

Output Settings

Output Response
Output Level: High Level(WC:closed) Output Duration: 5 (1-600) s

Alert Trigger Setting

Alarm Ring Duration: 5 (1-600) s
 Input Trigger: Disable Ring
 Remote DTMF Trigger: Enable Ring
 Remote SMS Trigger: Disable Ring
 Call State Trigger: Talking

Output Last: By Duration
Trigger Code: 1234
Trigger Message: ALERT=OUT_SOS

Apply

Tamper Alarm Settings

Tamper Alarm

Alarm command

Tamper_Alarm

Reset command

Tamper_Reset

Reset Alerting Status

Reset

Ring Type

Default

Apply

Server Settings

Server Address

Send message to the server when the alarm is triggered

Message:Alarm_Info:Description=Sip Door Phone;SIP User=5528;Mac=0c:38:3e:20:d0:c6;IP=172.18.3.57;port=Input1

Apply

Security Settings	
Field Name	Explanation
Input Settings	
Input Detect	Enable input detection
Trigger mode	Low Level Trigger(Close Trigger),Double short circuit detection port(If it is single port, is the low level) Detection to trigger when closed.
	High Level Trigger(Disconnect Trigger),Double short circuit detection port(If it is single port, is the high level)Detection to trigger when disconnect.
Alert message send to server	When meet the input port to trigger condition, to the server sends the alarm information correspondence.
Output Settings	
Output Response	Enable output port detection
Output Level	Low Level(NO: always on)When meet the trigger condition, trigger the NO port disconnected.
	High Level(NC: always off)When meet the trigger condition, trigger the NC port close.
Output Duration	Define the output duration change of output port. (1-600S)
Alert Trigger Setting	
Alarm Ring Duration	Define the output duration change of output port. (1-600S)
Input Trigger	When the input port meet to trigger condition, the output port will trigger
Remote DTMF Trigger	By Duration : Received the terminal equipment to send the DTMF password, if correct, which triggers the corresponding output port (The Port leveltime change, By < Output Duration> control)
	By Calling State : During the call, receive the terminal equipment to send the DTMF password, if correct, which triggers the corresponding output port (The Port level time change, By call state control, after the end of the call, port to return the default state)
Remote SMS Trigger	In the remote device or server to send instructions to ALERT=[instructions], if correct, which triggers the corresponding output port
Call State Trigger	The port output continuous time synchronization and trigger state changes, including the trigger conditions: 1, call; 2, call and singing; 3, singing; three models. (for example: the call trigger output port, will be in conversation state continued to output the corresponding level)

Call State Trigger	The port output continuous time synchronization and trigger state changes, including the trigger conditions: 1, call; 2, call and singing; 3, singing; three models. (for example: the call trigger output port, will be in conversation state continued to output the corresponding level)
Tamper Alarm Settings	
Tamper Alarm	When the selection is enabled, the tamper detection enabled
Alarm Command	When detected someone tampering the equipment, will be sent alarm to the corresponding server
Reset Command	When the equipment receives the command of reset from server, the equipment will stop alarm
Reset Alerting Status	Directly stop the alarm from equipment in the Web page
Server Settings	
Server Address	Configure remote response server address(including remote response server address and tamper alarm server address)

7 Intercom Settings

The broadcast terminal configuration notice

- 1) When the terminal use as broadcast, the speaker is loud, if not set mute for microphone, the AEC (echo cancellation) of equipment will be activated, which leads the sound incoherence. In order to avoid such circumstance, when the equipment turn to use as radio should be set as intercom mode, and activate the intercom mute, so as to ensure the broadcast quality.

Features	Audio	Video	MCAST	Action URL	Time/Date
System	Enable DND <input type="checkbox"/>				
Network	Enable Intercom Mute <input checked="" type="checkbox"/>			Ban Outgoing <input type="checkbox"/>	
Line	Enable Auto Answer <input type="checkbox"/>			Enable Intercom Ringing <input checked="" type="checkbox"/>	
Intercom settings	Auto Answer Lines and IP Call <input type="text"/>			Auto Answer Timeout <input type="text" value="0"/> (0-60)Second(s)	
Security settings	No Answer Auto Hangup <input type="checkbox"/>			Auto Hangup Timeout <input type="text" value="30"/> (1-60)Second(s)	
	Voice Read IP <input type="checkbox"/>			Voice Play Language <input type="text" value="English"/>	
	Enable Delay Start <input type="checkbox"/>			Delay Start Time <input type="text" value="1"/> (1-180)Second(s)	
	Description <input type="text" value="118S"/>				
				Apply	

- 2) How to improve broadcasting tone quality?

In order to obtain better broadcast quality, recommend the use of the HD (G.722) mode for broadcast.

Voice bandwidth will be by the narrow width (G.722) of 4 KHz, is extended to broadband (G.722)7 KHz, when combined with the active speaker, the effect will be better.

Features	Audio	Video	MCAST	Action URL	Time/Date
System					
Network					
Line					
Intercom settings					
Security settings					
Function Key					
	Audio Settings				
	First Codec <input type="text" value="G.722"/>			Second Codec <input type="text" value="G.711A"/>	
	Third Codec <input type="text" value="G.711U"/>			Fourth Codec <input type="text" value="G.729AB"/>	
	Fifth Codec <input type="text" value="None"/>			Sixth Codec <input type="text" value="None"/>	
	DTMF Payload Type <input type="text" value="101"/> (96-127)			Default Ring Type <input type="text" value="Type 9"/>	
	G.729AB Payload Length <input type="text" value="20ms"/>			Tone Standard <input type="text" value="United St."/>	
	G.722 Timestamps <input type="text" value="160/20ms"/>			G.723.1 Bit Rate <input type="text" value="6.3kb/s"/>	
	Speakerphone Volume <input type="text" value="5"/> (1-9)			MIC Input Volume <input type="text" value="5"/> (1-9)	
	Broadcast Output Volume <input type="text" value="5"/> (1-9)			Signal Tone Volume <input type="text" value="4"/> (0-9)	
	Enable VAD <input type="checkbox"/>				
				Apply	



Fanvil Technology Co., Ltd

Tel: +86-755-2640-2199 Fax: +86-755-2640-2618 Email: sales@fanvil.com
Add: 4F, Block A, Building 1#, GaoXinQi Hi-Tech Park (Phase-II), 67th District, Bao'An,
Shenzhen, China 518101